

DUAL J-FET INPUT OPERATIONAL AMPLIFIER

■ GENERAL DESCRIPTION

The NJM2082 is JFET input dual operational amplifiers. The NJM2082 features low input offset and bias current, high input impedance. The NJM2082 ideally suits for fast integrator, DA converter, sample & hold and audio applications. The NJM2082 is improved version of the NJM082.

■ FEATURES

- Operating Voltage ($\pm 4V \sim \pm 18V$)
- High Input Resistance ($10^{12}\Omega$ typ.)
- High Slew Rate ($20V/\mu s$ typ.)
- Package Outline DIP8, DMP8, SIP8, SSOP8
- Bipolar Technology

■ PACKAGE OUTLINE

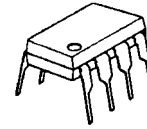

NJM2082D



NJM2082M



NJM2082V

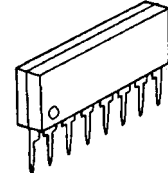

NJM2082L

■ PIN CONFIGURATION

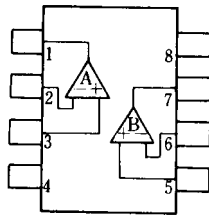

NJM2082D
NJM2082M
NJM2082V

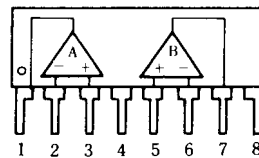

NJM2082L

- PIN FUNCTION**
- 1.A OUTPUT
 - 2.A -INPUT
 - 3.A +INPUT
 - 4.V⁻
 - 5.B +INPUT
 - 6.B -INPUT
 - 7.B OUTPUT
 - 8.V⁺

■ EQUIVALENT CIRCUIT (1/2 Shown)

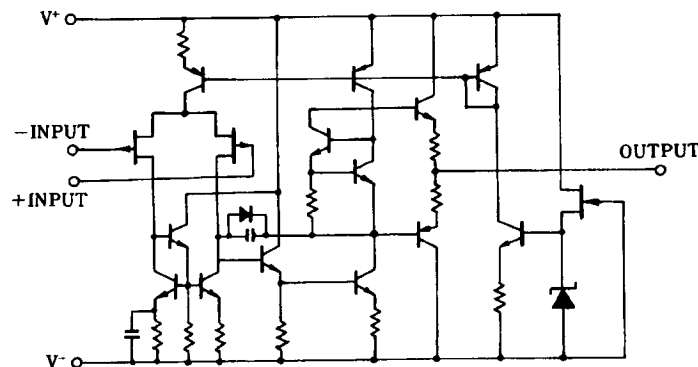

NJM2082

■ ABSOLUTE MAXIMUM RATINGS

(Ta=25°C)

PARAMETER	SYMBOL	RATINGS	UNIT
Supply Voltage	V^+ / V^-	± 18	V
Differential Input Voltage	V_{ID}	± 30	V
Input Voltage	V_{IC}	± 15 (note)	V
Power Dissipation	P_D	(DIP8) 500 (DMP8) 300 (SIP8) 800 (SSOP8) 250	mW
Operating Temperature Range	T_{opr}	-40~+85	°C
Storage Temperature Range	T_{stg}	-40~+125	°C

(note) For supply voltage less than ±15V, the absolute maximum input voltage is equal to the supply voltage.

■ ELECTRICAL CHARACTERISTICS

(Ta=+25°C, $V^+ / V^- = \pm 15V$)

PARAMETER	SYMBOL	TEST CONDITION	MIN.	TYP.	MAX.	UNIT
Input Offset Voltage	V_{IO}	$R_S = 50\Omega$	-	2	10	mV
Input Offset Current	I_{IO}		-	5	200	pA
Input Bias Current	I_B		-	30	400	pA
Input Resistance	R_{IN}		-	10^{12}	-	Ω
Large Signal Voltage Gain	A_V	$R_L \geq 2k\Omega, V_O = \pm 10V$	86	110	-	dB
Maximum Output Voltage Swing	V_{OM}	$R_L = 2k\Omega$	± 12	+13.5, -13.0	-	V
Input Common Mode Voltage Range	V_{ICM}		± 12	+15.0, -12.5	-	V
Common Mode Rejection Ratio	CMR	$R_S \leq 10k\Omega$	70	90	-	dB
Supply Voltage Rejection Ratio	SVR	$R_S \leq 10k\Omega$	76	100	-	dB
Operating Current	I_{CC}		-	4	6	mA
Slew Rate	SR		-	20	-	V/ μ s
Gain Bandwidth Product	GB	$f = 10kHz$	-	5	-	MHz
Equivalent Input Noise Voltage 1	e_n	$R_S = 100\Omega, f = 1kHz$	-	13	-	nV/ \sqrt{Hz}
Equivalent Input Noise Voltage 2	V_{NI}	RIAA $R_S = 2.2k\Omega, 30kHz$ LPF	-	1.6	-	μ Vrms

■ TYPICAL CHARACTERISTICS

Voltage Gain vs. Frequency

($V^+/V^- = \pm 15V$, $R_L = 2k\Omega$, $T_a = 25^\circ C$)

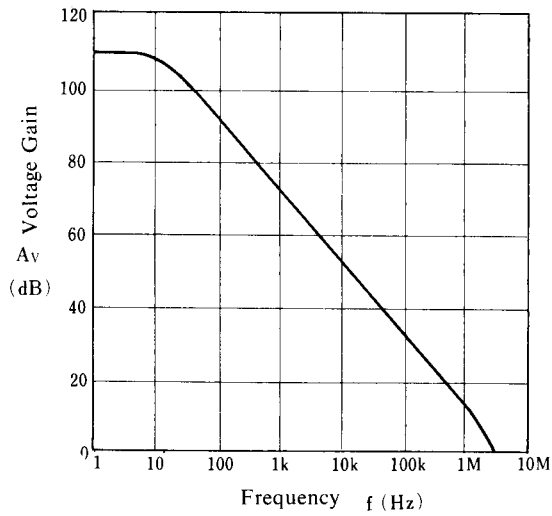

Maximum Output Voltage Swing vs. Load Resistance

($V^+/V^- = \pm 15V$, $T_a = 25^\circ C$)

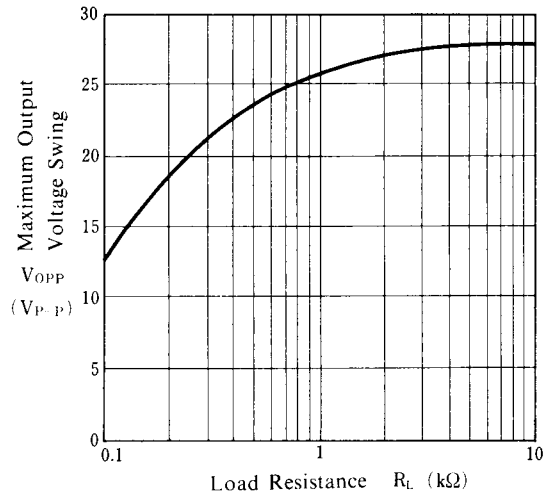

Maximum Output Voltage Swing vs. Frequency

($R_L = 2k\Omega$, $T_a = 25^\circ C$)

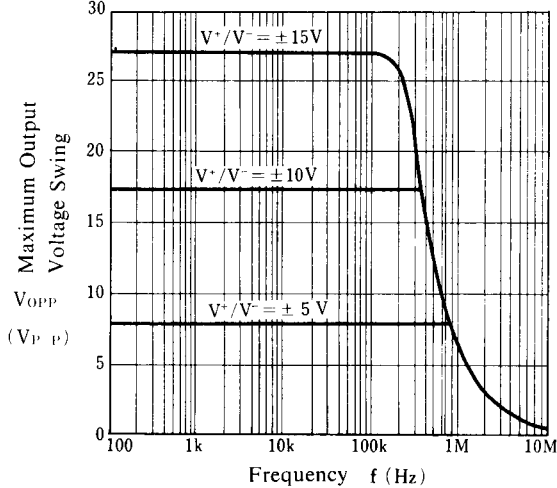

Equivalent Input Noise Voltage vs. Frequency

($V^+/V^- = \pm 15V$, $R_s = 100\Omega$, $T_a = 25^\circ C$)

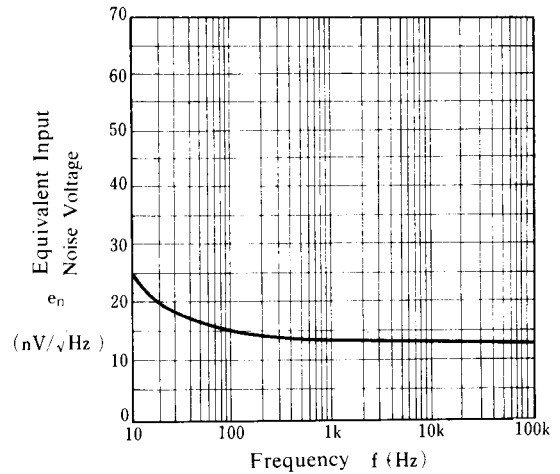

Equivalent Input Noise Voltage vs. Source Resistance

($V^+/V^- = \pm 15V$, $T_a = 25^\circ C$)

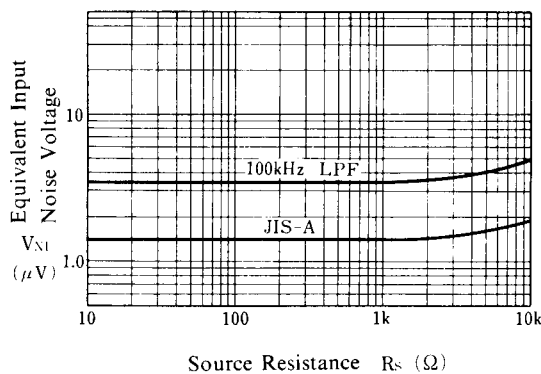

Voltage Follower Pulse Response

($V^+/V^- = \pm 15V$, $R_L = 2k\Omega$, $C_L = 100pF$, $T_a = 25^\circ C$)

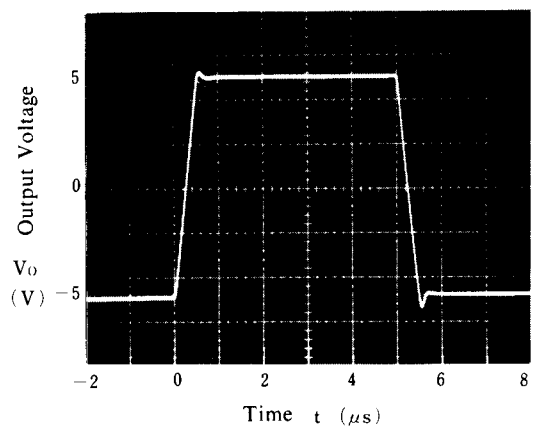

■ TYPICAL CHARACTERISTICS

Operating Current vs. Temperature

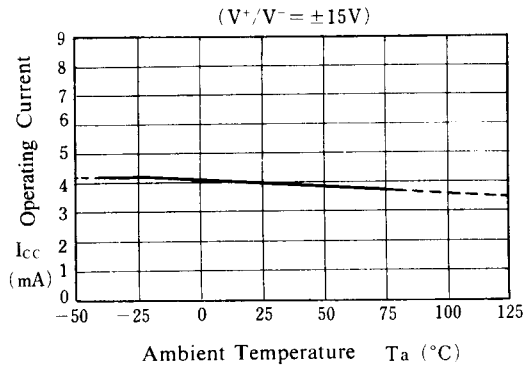

Maximum Output Voltage Swing vs. Temperature

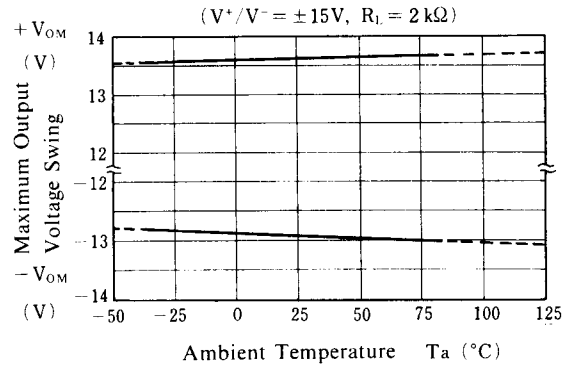

Input Offset Voltage vs. Temperature

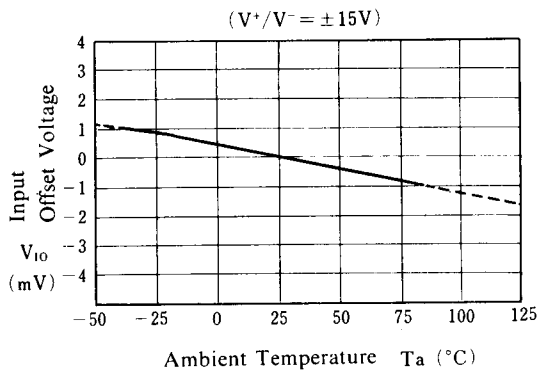

Input Bias Current vs. Temperature

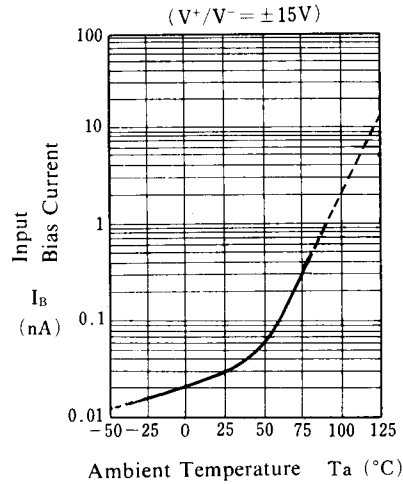

Operating Current vs. Operating Voltage

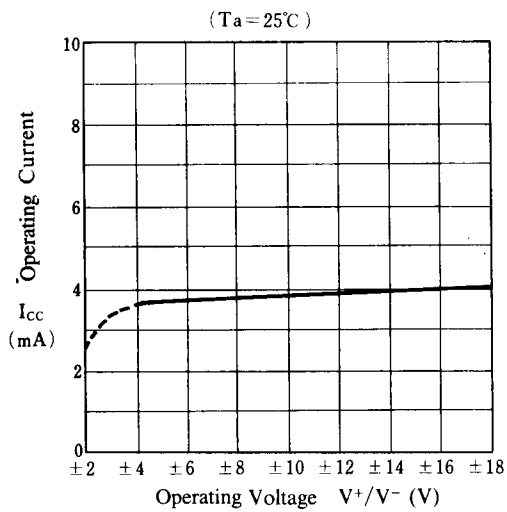

Maximum Output Voltage Swing vs. Operating Voltage

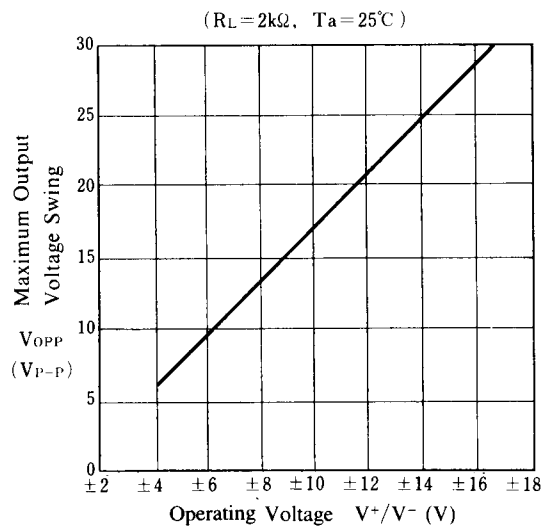

[CAUTION]

The specifications on this databook are only given for information, without any guarantee as regards either mistakes or omissions. The application circuits in this databook are described only to show representative usages of the product and not intended for the guarantee or permission of any right including the industrial rights.