

Automotive high voltage power Schottky rectifier

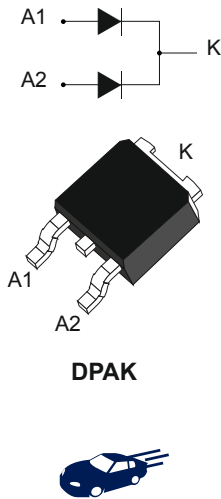

Features

- AEC-Q101 qualified
- Negligible switching losses
- Low leakage current
- Good trade-off between leakage current and forward voltage drop
- Low thermal resistance
- Avalanche capability specified
- PPAP capable

Description

Dual center tab Schottky rectifier suited for switched mode power supply and high frequency DC to DC converters.

Packaged in DPAK, the [STPS15H100C-Y](#) is intended for use in high frequency LED head lamp circuits for automotive applications.

Product status	
STPS15H100C-Y	
Product summary	
Symbol	Value
$I_{F(AV)}$	2 x 7.5 A
V_{RRM}	100 V
$T_{j(max.)}$	175 °C
$V_{F(max.)}$	0.67 V

1 Characteristics

Table 1. Absolute ratings (limiting values, per diode, at 25 °C unless otherwise specified)

Symbol	Parameter		Value	Unit	
V _{RRM}	Repetitive peak reverse voltage		100	V	
I _{F(RMS)}	Forward rms current		10	A	
I _{F(AV)}	Average forward current	T _c = 150 °C, δ = 0.5 square wave	Per diode	7.5	A
		T _c = 145 °C, δ = 0.5 square wave	Per device	15	
I _{FSM}	Surge non repetitive forward current	t _p = 10 ms sinusoidal	75	A	
P _{ARM}	Repetitive peak avalanche power	t _p = 10 μs, T _j = 125 °C	475	W	
T _{stg}	Storage temperature range		-65 to +175	°C	
T _j	Operating junction temperature range ⁽¹⁾		-40 to +175	°C	

1. $(dP_{tot}/dT_j) < (1/R_{th(j-a)})$ condition to avoid thermal runaway for a diode on its own heatsink.

Table 2. Thermal resistance parameters

Symbol	Parameter		Max. value	Unit
R _{th(j-c)}	Junction to case	Per diode	4	°C/W
		Total	2.4	
R _{th(c)}	Coupling		0.7	

When the diodes 1 and 2 are used simultaneously :

$$\Delta T_j(\text{diode 1}) = P(\text{diode 1}) \times R_{th(j-c)}(\text{per diode}) + P(\text{diode 2}) \times R_{th(c)}$$

Table 3. Static electrical characteristics (per diode)

Symbol	Parameter	Test conditions		Min.	Typ.	Max.	Unit
I _R ⁽¹⁾	Reverse leakage current	T _j = 25 °C	V _R = V _{RRM}	-		3	μA
		T _j = 125 °C		-	1.3	4	mA
V _F ⁽²⁾	Forward voltage drop	T _j = 25 °C	I _F = 7.5 A	-		0.8	V
		T _j = 125 °C		-	0.62	0.67	
		T _j = 25 °C	I _F = 12 A	-		0.85	
		T _j = 125 °C		-	0.68	0.73	
		T _j = 25 °C	I _F = 15 A	-		0.89	
		T _j = 125 °C		-	0.71	0.76	

1. t_p = 5 ms, δ < 2%

2. t_p = 380 μs, δ < 2%

To evaluate the conduction losses, use the following equation:

$$P = 0.58 \times I_{F(AV)} + 0.012 \times I_{F(RMS)}^2$$

1.1 Characteristics (curves)

Figure 1. Average forward power dissipation versus average forward current (per diode)

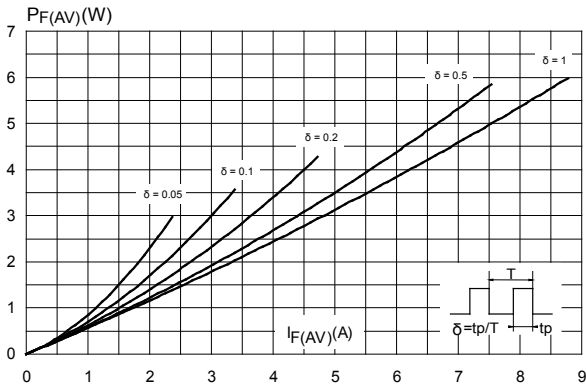

Figure 2. Average forward current versus ambient temperature ($\delta = 0.5$, per diode)

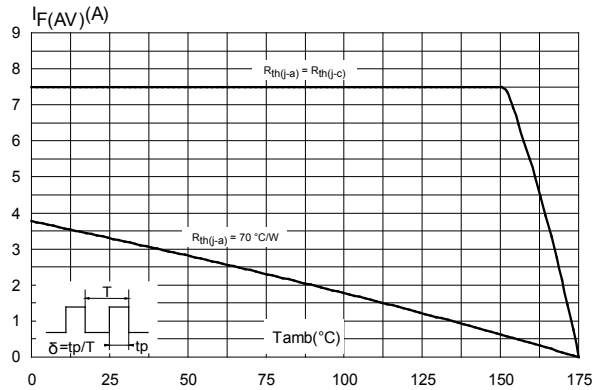

Figure 3. Normalized avalanche power derating versus pulse duration ($T_j = 125\text{ }^{\circ}\text{C}$)

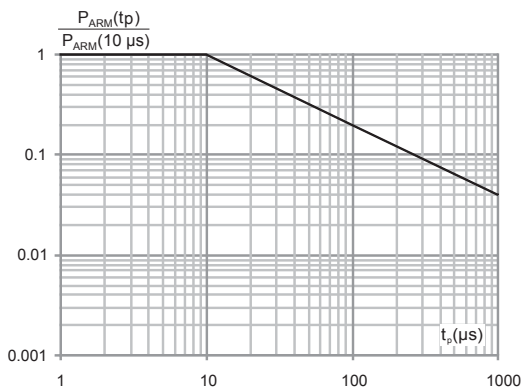

Figure 4. Relative variation of thermal impedance junction to case versus pulse duration

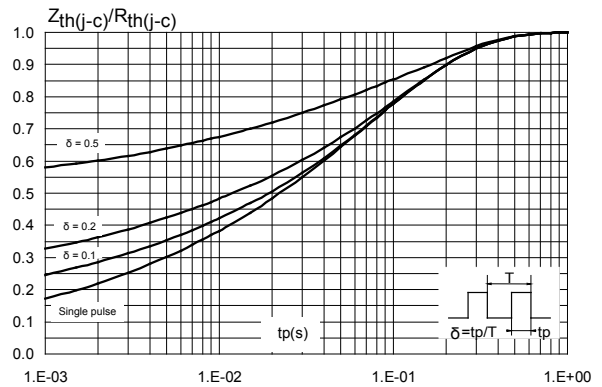

Figure 5. Reverse leakage current versus reverse voltage applied (typical values, per diode)

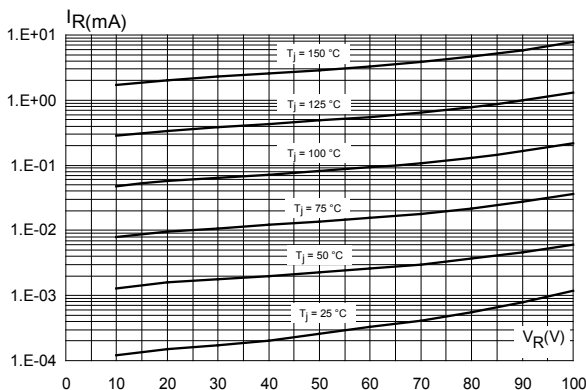

Figure 6. Junction capacitance versus reverse voltage applied (typical values, per diode)

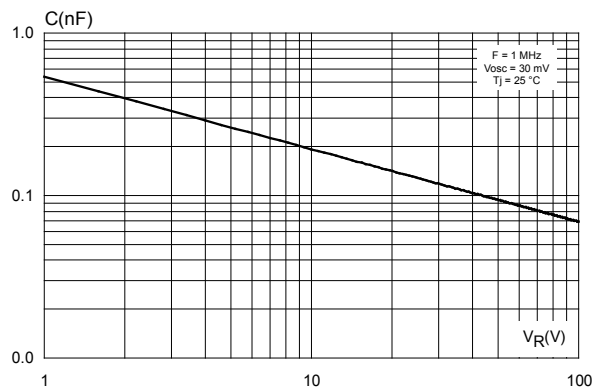

Figure 7. Forward voltage drop versus forward current (per diode)

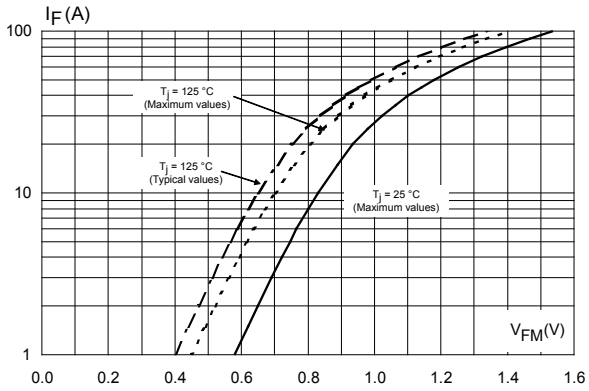
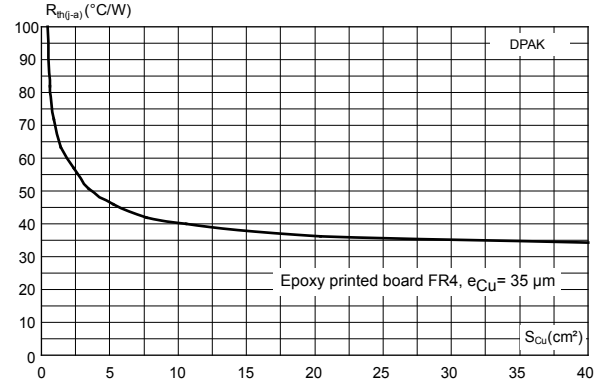

Figure 8. Thermal resistance junction to ambient versus copper surface under tab



2 Package information

In order to meet environmental requirements, ST offers these devices in different grades of ECOPACK® packages, depending on their level of environmental compliance. ECOPACK® specifications, grade definitions and product status are available at: www.st.com. ECOPACK® is an ST trademark.

2.1 DPAK package information

- Epoxy meets UL94, V0
- Lead-free packages

Figure 9. DPAK package outline

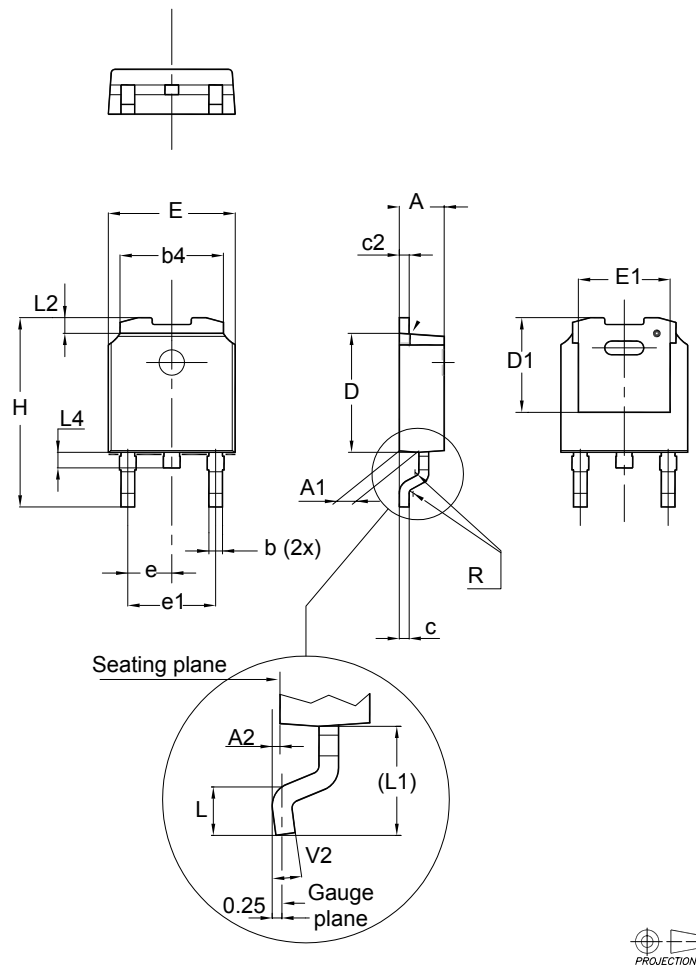

3 Ordering Information

Table 5. Ordering information

Order code	Marking	Package	Weight	Base qty.	Delivery mode
STPS15H100CBY-TR	S15 H100Y	DPAK	0.30 g	2500	Tape and reel

Revision history

Table 6. Document revision history

Date	Version	Changes
04-Nov-2011	1	Initial release.
16-Apr-2018	2	Updated Figure 3. Normalized avalanche power derating versus pulse duration ($T_j = 125\text{ °C}$), Table 1. Absolute ratings (limiting values, per diode, at 25 °C unless otherwise specified) and Section • Description. Removed figure 4.

IMPORTANT NOTICE – PLEASE READ CAREFULLY

STMicroelectronics NV and its subsidiaries (“ST”) reserve the right to make changes, corrections, enhancements, modifications, and improvements to ST products and/or to this document at any time without notice. Purchasers should obtain the latest relevant information on ST products before placing orders. ST products are sold pursuant to ST’s terms and conditions of sale in place at the time of order acknowledgement.

Purchasers are solely responsible for the choice, selection, and use of ST products and ST assumes no liability for application assistance or the design of Purchasers’ products.

No license, express or implied, to any intellectual property right is granted by ST herein.

Resale of ST products with provisions different from the information set forth herein shall void any warranty granted by ST for such product.

ST and the ST logo are trademarks of ST. All other product or service names are the property of their respective owners.

Information in this document supersedes and replaces information previously supplied in any prior versions of this document.

© 2018 STMicroelectronics – All rights reserved