

NVMFS6B14N

Power MOSFET

100 V, 15 mΩ, 55 A, Single N-Channel

Features

- Small Footprint (5x6 mm) for Compact Design
- Low $R_{DS(on)}$ to Minimize Conduction Losses
- Low Q_G and Capacitance to Minimize Driver Losses
- NVMFS6B14NWF – Wettable Flank Option for Enhanced Optical Inspection
- AEC-Q101 Qualified and PPAP Capable
- These Devices are Pb-Free and are RoHS Compliant

MAXIMUM RATINGS ($T_J = 25^\circ\text{C}$ unless otherwise noted)

Parameter	Symbol	Value	Unit	
Drain-to-Source Voltage	V_{DSS}	100	V	
Gate-to-Source Voltage	V_{GS}	± 16	V	
Continuous Drain Current $R_{\theta JC}$ (Notes 1, 2, 3)	Steady State	$T_C = 25^\circ\text{C}$	I_D 55	A
		$T_C = 100^\circ\text{C}$	39	
Power Dissipation $R_{\theta JC}$ (Notes 1, 2)	Steady State	$T_C = 25^\circ\text{C}$	P_D 94	W
		$T_C = 100^\circ\text{C}$	47	
Continuous Drain Current $R_{\theta JA}$ (Notes 1, 2, 3)	Steady State	$T_A = 25^\circ\text{C}$	I_D 11	A
		$T_A = 100^\circ\text{C}$	8.0	
Power Dissipation $R_{\theta JA}$ (Notes 1 & 2)	Steady State	$T_A = 25^\circ\text{C}$	P_D 3.8	W
		$T_A = 100^\circ\text{C}$	1.9	
Pulsed Drain Current	$T_A = 25^\circ\text{C}, t_p = 10 \mu\text{s}$	I_{DM} 140	A	
Operating Junction and Storage Temperature	T_J, T_{stg}	-55 to +175	$^\circ\text{C}$	
Source Current (Body Diode)	I_S	60	A	
Single Pulse Drain-to-Source Avalanche Energy ($T_J = 25^\circ\text{C}, V_{DD} = 50 \text{ V}, V_{GS} = 10 \text{ V}, I_{L(pk)} = 24 \text{ A}, L = 0.1 \text{ mH}, R_G = 25 \Omega$)	E_{AS}	29	mJ	
Lead Temperature for Soldering Purposes (1/8" from case for 10 s)	T_L	260	$^\circ\text{C}$	

Stresses exceeding those listed in the Maximum Ratings table may damage the device. If any of these limits are exceeded, device functionality should not be assumed, damage may occur and reliability may be affected.

THERMAL RESISTANCE MAXIMUM RATINGS

Parameter	Symbol	Value	Unit
Junction-to-Case – Steady State	$R_{\theta JC}$	1.6	$^\circ\text{C}/\text{W}$
Junction-to-Ambient – Steady State (Note 2)	$R_{\theta JA}$	40	

1. The entire application environment impacts the thermal resistance values shown, they are not constants and are only valid for the particular conditions noted.
2. Surface-mounted on FR4 board using a 650 mm², 2 oz. Cu pad.
3. Maximum current for pulses as long as 1 second is higher but is dependent on pulse duration and duty cycle.



ON Semiconductor®

www.onsemi.com

$V_{(BR)DSS}$	$R_{DS(ON)} \text{ MAX}$	$I_D \text{ MAX}$
100 V	15 mΩ @ 10 V	55 A

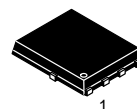
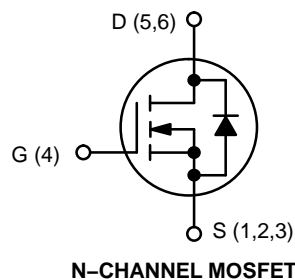

DFN5 (SO-8FL) CASE 488AA STYLE 1

MARKING DIAGRAM

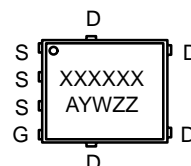

- A = Assembly Location
- Y = Year
- W = Work Week
- ZZ = Lot Traceability

ORDERING INFORMATION

See detailed ordering, marking and shipping information on page 5 of this data sheet.

NVMFS6B14N

ELECTRICAL CHARACTERISTICS ($T_J = 25^\circ\text{C}$ unless otherwise specified)

Parameter	Symbol	Test Condition	Min	Typ	Max	Unit
-----------	--------	----------------	-----	-----	-----	------

OFF CHARACTERISTICS

Drain-to-Source Breakdown Voltage	$V_{(BR)DSS}$	$V_{GS} = 0\text{ V}, I_D = 250\ \mu\text{A}$	100			V
Drain-to-Source Breakdown Voltage Temperature Coefficient	$V_{(BR)DSS}/T_J$			80		mV/°C
Zero Gate Voltage Drain Current	I_{DSS}	$V_{GS} = 0\text{ V}, V_{DS} = 80\text{ V}$	$T_J = 25^\circ\text{C}$		10	μA
			$T_J = 125^\circ\text{C}$		100	
Gate-to-Source Leakage Current	I_{GSS}	$V_{DS} = 0\text{ V}, V_{GS} = 16\text{ V}$			100	nA

ON CHARACTERISTICS (Note 4)

Gate Threshold Voltage	$V_{GS(TH)}$	$V_{GS} = V_{DS}, I_D = 250\ \mu\text{A}$	2.0		4.0	V
Negative Threshold Temperature Coefficient	$V_{GS(TH)}/T_J$			-8.5		mV/°C
Drain-to-Source On Resistance	$R_{DS(on)}$	$V_{GS} = 10\text{ V}, I_D = 20\text{ A}$		12.2	15	m Ω

CHARGES, CAPACITANCES & GATE RESISTANCE

Input Capacitance	C_{ISS}	$V_{GS} = 0\text{ V}, f = 1\text{ MHz}, V_{DS} = 50\text{ V}$		1300		pF
Output Capacitance	C_{OSS}			260		
Reverse Transfer Capacitance	C_{RSS}			18		
Total Gate Charge	$Q_{G(TOT)}$	$V_{GS} = 10\text{ V}, V_{DS} = 50\text{ V}; I_D = 20\text{ A}$		20		nC
Threshold Gate Charge	$Q_{G(TH)}$			2.2		
Gate-to-Source Charge	Q_{GS}			6.4		
Gate-to-Drain Charge	Q_{GD}			6.5		
Plateau Voltage	V_{GP}			5.4		
Gate Resistance	R_G	$T_J = 25^\circ\text{C}$		1.0		Ω

SWITCHING CHARACTERISTICS (Note 5)

Turn-On Delay Time	$t_{d(ON)}$	$V_{GS} = 10\text{ V}, V_{DS} = 50\text{ V}, I_D = 20\text{ A}, R_G = 1.0\ \Omega$		9.6		ns
Rise Time	t_r			39		
Turn-Off Delay Time	$t_{d(OFF)}$			16.6		
Fall Time	t_f			6.8		

DRAIN-SOURCE DIODE CHARACTERISTICS

Forward Diode Voltage	V_{SD}	$V_{GS} = 0\text{ V}, I_S = 20\text{ A}$	$T_J = 25^\circ\text{C}$		0.83	1.2	V
			$T_J = 125^\circ\text{C}$		0.8		
Reverse Recovery Time	t_{RR}	$V_{GS} = 0\text{ V}, dI_S/dt = 100\text{ A}/\mu\text{s}, I_S = 20\text{ A}$		45		ns	
Charge Time	t_a			23			
Discharge Time	t_b			22			
Reverse Recovery Charge	Q_{RR}			50			nC

Product parametric performance is indicated in the Electrical Characteristics for the listed test conditions, unless otherwise noted. Product performance may not be indicated by the Electrical Characteristics if operated under different conditions.

4. Pulse Test: pulse width $\leq 300\ \mu\text{s}$, duty cycle $\leq 2\%$.

5. Switching characteristics are independent of operating junction temperatures.

TYPICAL CHARACTERISTICS

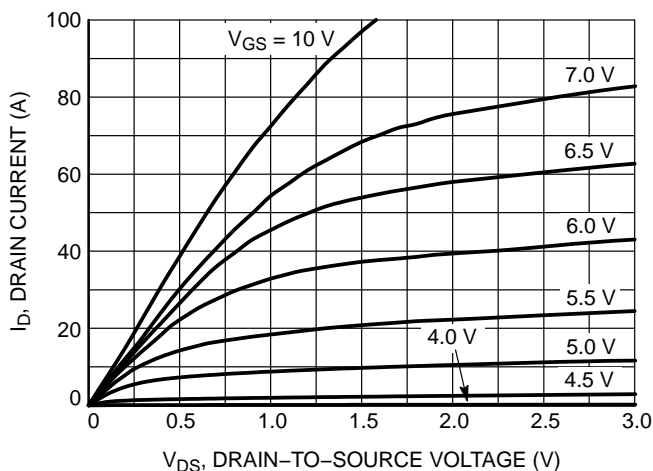

Figure 1. On-Region Characteristics

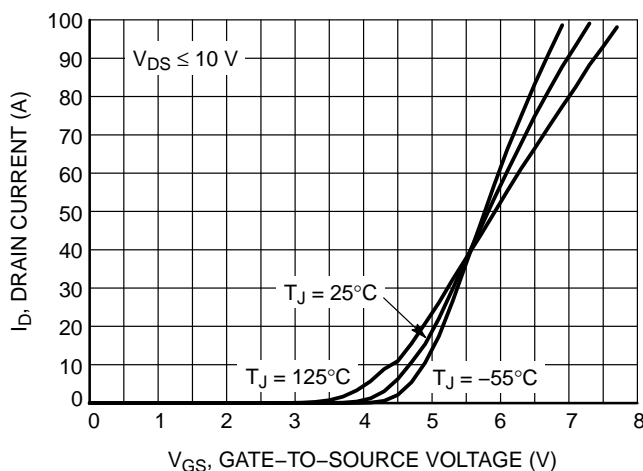

Figure 2. Transfer Characteristics

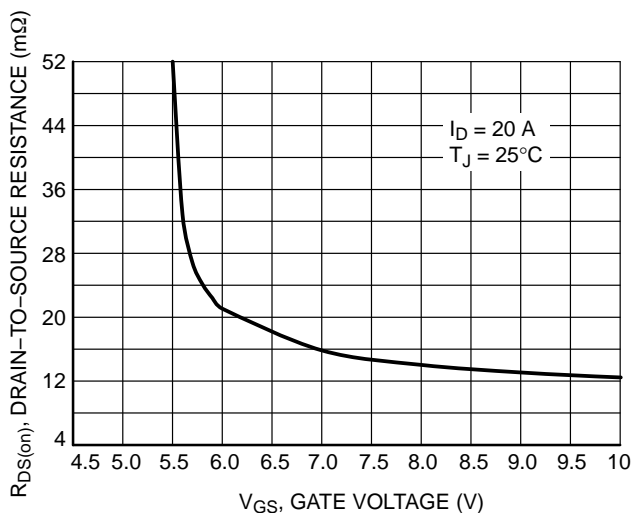

Figure 3. On-Resistance vs. Gate-to-Source Voltage

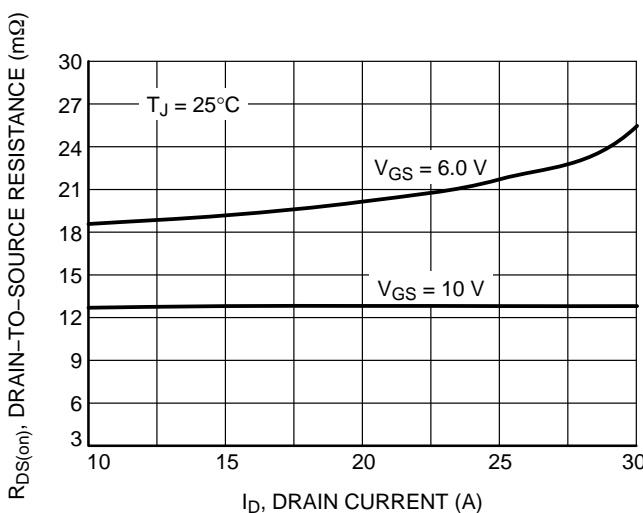

Figure 4. On-Resistance vs. Drain Current and Gate Voltage

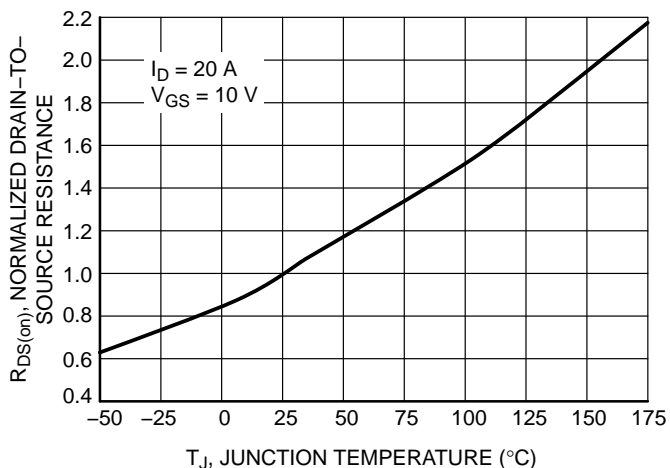

Figure 5. On-Resistance Variation with Temperature

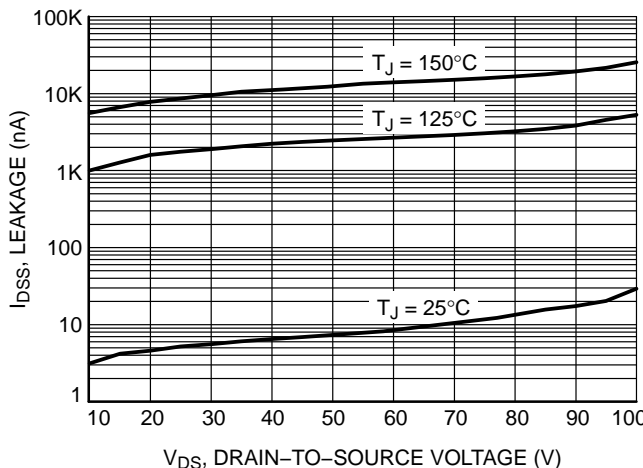

Figure 6. Drain-to-Source Leakage Current vs. Voltage

NVMFS6B14N

TYPICAL CHARACTERISTICS

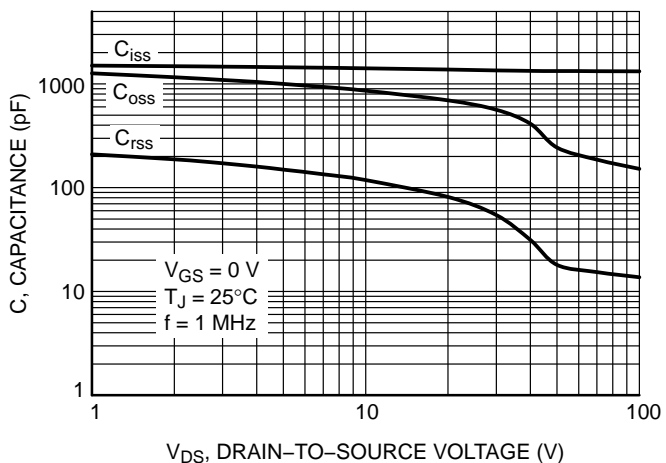

Figure 7. Capacitance Variation

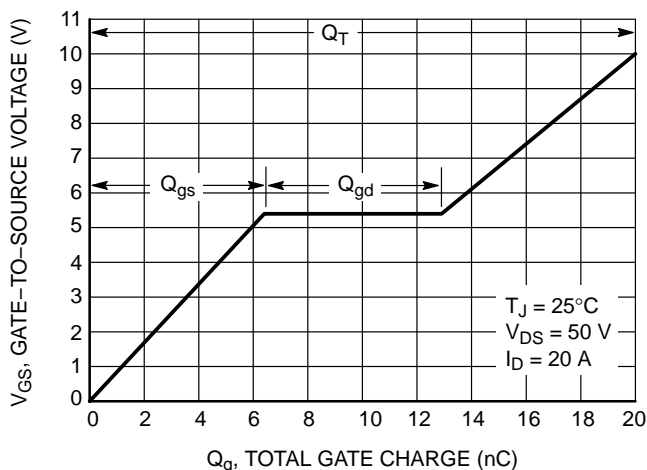

Figure 8. Gate-to-Source and Drain-to-Source Voltage vs. Total Charge

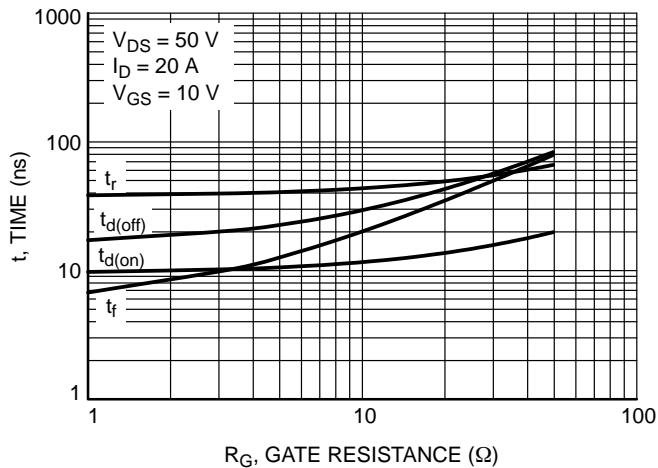

Figure 9. Resistive Switching Time Variation vs. Gate Resistance

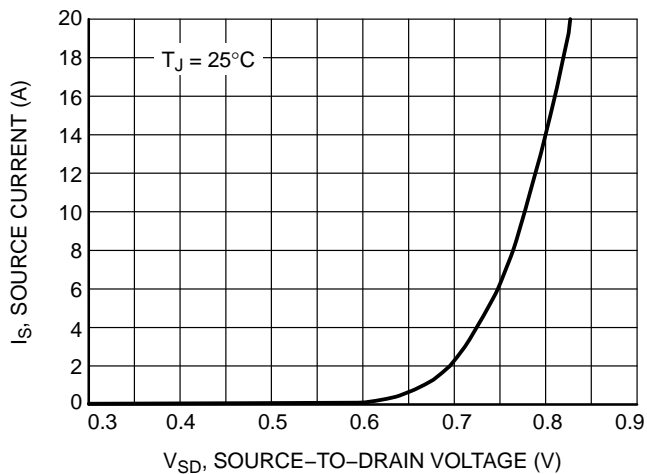

Figure 10. Diode Forward Voltage vs. Current

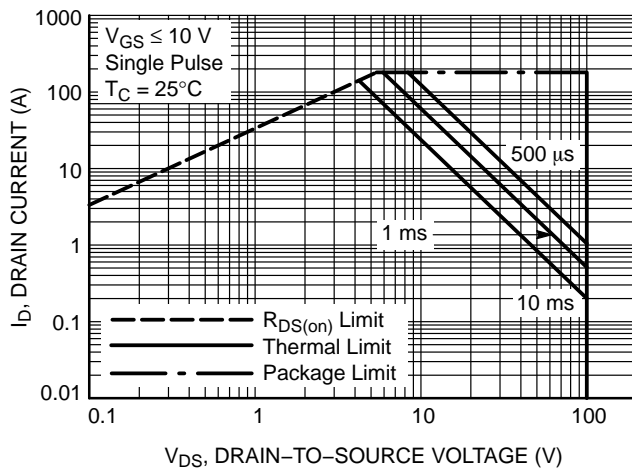

Figure 11. Maximum Rated Forward Biased Safe Operating Area

NVMFS6B14N

TYPICAL CHARACTERISTICS

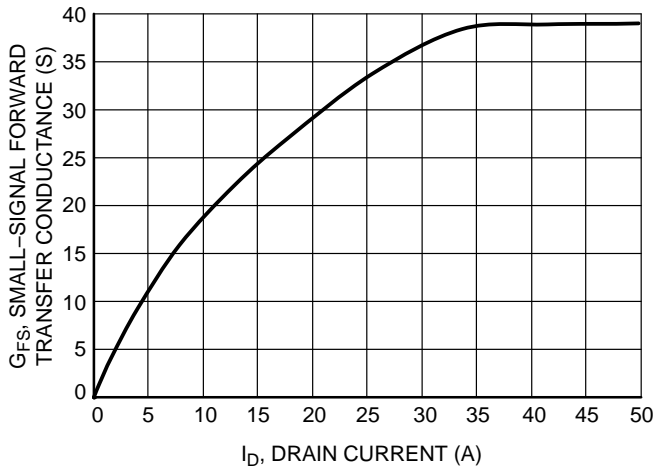

Figure 12. G_{FS} vs. I_D

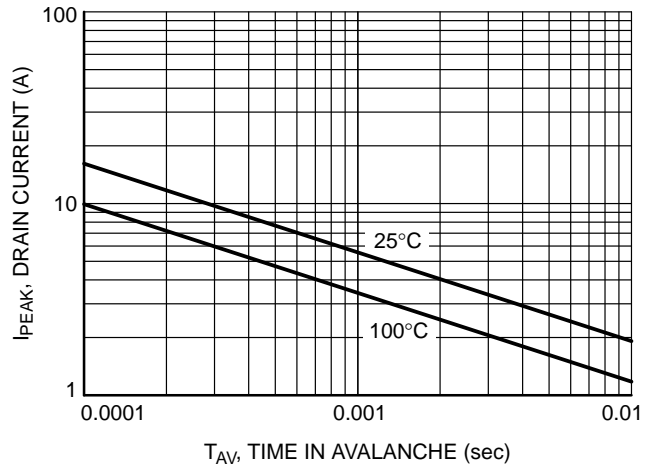

Figure 13. I_{PEAK} vs. T_{AV}

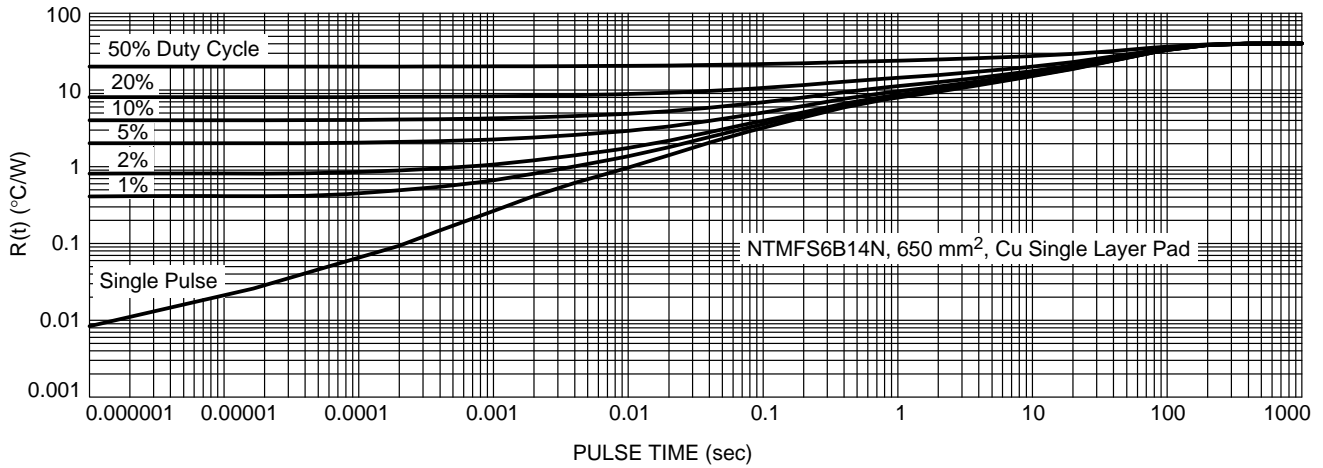

Figure 14. Thermal Response

DEVICE ORDERING CYCLE INFORMATION

Device	Marking	Package	Shipping†
NVMFS6B14NT1G	6B14N	DFN5 (Pb-Free)	1500 / Tape & Reel
NVMFS6B14NWFT1G	6B14WF	DFN5 (Pb-Free, Wettable Flanks)	1500 / Tape & Reel
NVMFS6B14NT3G	6B14N	DFN5 (Pb-Free)	5000 / Tape & Reel
NVMFS6B14NWFT3G	6B14WF	DFN5 (Pb-Free, Wettable Flanks)	5000 / Tape & Reel

†For information on tape and reel specifications, including part orientation and tape sizes, please refer to our Tape and Reel Packaging Specifications Brochure, BRD8011/D.

MECHANICAL CASE OUTLINE

PACKAGE DIMENSIONS



1
SCALE 2:1

DFN5 5x6, 1.27P
(SO-8FL)
CASE 488AA
ISSUE N

DATE 25 JUN 2018

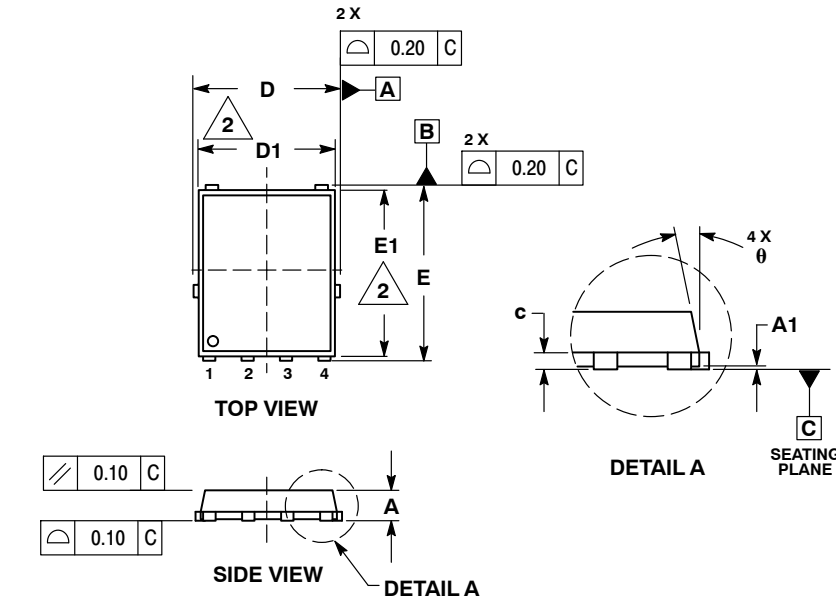

NOTES:

1. DIMENSIONING AND TOLERANCING PER ASME Y14.5M, 1994.
2. CONTROLLING DIMENSION: MILLIMETER.
3. DIMENSION D1 AND E1 DO NOT INCLUDE MOLD FLASH PROTRUSIONS OR GATE BURRS.

DIM	MILLIMETERS		
	MIN	NOM	MAX
A	0.90	1.00	1.10
A1	0.00	---	0.05
b	0.33	0.41	0.51
c	0.23	0.28	0.33
D	5.00	5.15	5.30
D1	4.70	4.90	5.10
D2	3.80	4.00	4.20
E	6.00	6.15	6.30
E1	5.70	5.90	6.10
E2	3.45	3.65	3.85
e	1.27 BSC		
G	0.51	0.575	0.71
K	1.20	1.35	1.50
L	0.51	0.575	0.71
L1	0.125 REF		
M	3.00	3.40	3.80
θ	0°	---	12°

GENERIC MARKING DIAGRAM*



- XXXXXX = Specific Device Code
- A = Assembly Location
- Y = Year
- W = Work Week
- ZZ = Lot Traceability

*This information is generic. Please refer to device data sheet for actual part marking. Pb-Free indicator, "G" or microdot "•", may or may not be present. Some products may not follow the Generic Marking.

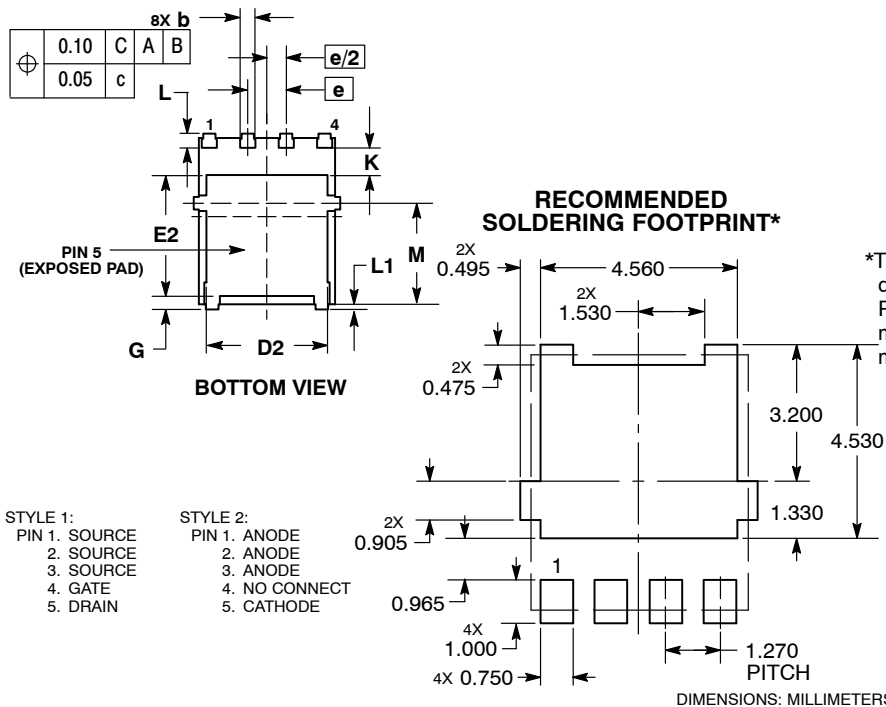

- STYLE 1:
PIN 1. SOURCE
2. SOURCE
3. SOURCE
4. GATE
5. DRAIN
- STYLE 2:
PIN 1. ANODE
2. ANODE
3. ANODE
4. NO CONNECT
5. CATHODE

DIMENSIONS: MILLIMETERS

*For additional information on our Pb-Free strategy and soldering details, please download the ON Semiconductor Soldering and Mounting Techniques Reference Manual, SOLDERRM/D.

DOCUMENT NUMBER:	98AON14036D	Electronic versions are uncontrolled except when accessed directly from the Document Repository. Printed versions are uncontrolled except when stamped "CONTROLLED COPY" in red.
DESCRIPTION:	DFN5 5x6, 1.27P (SO-8FL)	PAGE 1 OF 1

onsemi and ONSEMI are trademarks of Semiconductor Components Industries, LLC dba onsemi or its subsidiaries in the United States and/or other countries. onsemi reserves the right to make changes without further notice to any products herein. onsemi makes no warranty, representation or guarantee regarding the suitability of its products for any particular purpose, nor does onsemi assume any liability arising out of the application or use of any product or circuit, and specifically disclaims any and all liability, including without limitation special, consequential or incidental damages. onsemi does not convey any license under its patent rights nor the rights of others.

onsemi, **Onsemi**, and other names, marks, and brands are registered and/or common law trademarks of Semiconductor Components Industries, LLC dba "**onsemi**" or its affiliates and/or subsidiaries in the United States and/or other countries. **onsemi** owns the rights to a number of patents, trademarks, copyrights, trade secrets, and other intellectual property. A listing of **onsemi**'s product/patent coverage may be accessed at www.onsemi.com/site/pdf/Patent-Marking.pdf. **onsemi** reserves the right to make changes at any time to any products or information herein, without notice. The information herein is provided "as-is" and **onsemi** makes no warranty, representation or guarantee regarding the accuracy of the information, product features, availability, functionality, or suitability of its products for any particular purpose, nor does **onsemi** assume any liability arising out of the application or use of any product or circuit, and specifically disclaims any and all liability, including without limitation special, consequential or incidental damages. Buyer is responsible for its products and applications using **onsemi** products, including compliance with all laws, regulations and safety requirements or standards, regardless of any support or applications information provided by **onsemi**. "Typical" parameters which may be provided in **onsemi** data sheets and/or specifications can and do vary in different applications and actual performance may vary over time. All operating parameters, including "Typicals" must be validated for each customer application by customer's technical experts. **onsemi** does not convey any license under any of its intellectual property rights nor the rights of others. **onsemi** products are not designed, intended, or authorized for use as a critical component in life support systems or any FDA Class 3 medical devices or medical devices with a same or similar classification in a foreign jurisdiction or any devices intended for implantation in the human body. Should Buyer purchase or use **onsemi** products for any such unintended or unauthorized application, Buyer shall indemnify and hold **onsemi** and its officers, employees, subsidiaries, affiliates, and distributors harmless against all claims, costs, damages, and expenses, and reasonable attorney fees arising out of, directly or indirectly, any claim of personal injury or death associated with such unintended or unauthorized use, even if such claim alleges that **onsemi** was negligent regarding the design or manufacture of the part. **onsemi** is an Equal Opportunity/Affirmative Action Employer. This literature is subject to all applicable copyright laws and is not for resale in any manner.

ADDITIONAL INFORMATION

TECHNICAL PUBLICATIONS:

Technical Library: www.onsemi.com/design/resources/technical-documentation
onsemi Website: www.onsemi.com

ONLINE SUPPORT: www.onsemi.com/support

For additional information, please contact your local Sales Representative at www.onsemi.com/support/sales