

MBR1635, MBR1645, MBRB1645, NRVBB1645

Switch-mode Power Rectifiers

16 A, 35 and 45 V

These state-of-the-art devices use the Schottky Barrier principle with a platinum barrier metal.

Features

- Guard-ring for Stress Protection
- Low Forward Voltage
- 175°C Operating Junction Temperature
- NRVB Prefix for Automotive and Other Applications Requiring Unique Site and Control Change Requirements; AEC-Q101 Qualified and PPAP Capable
- These Devices are Pb-Free and are RoHS Compliant

Mechanical Characteristics:

- Case: Epoxy, Molded
- Weight: 1.9 Grams for TO-220
1.7 Grams for D²PAK
- Finish: All External Surfaces Corrosion Resistant and Terminal Leads are Readily Solderable
- Lead Temperature for Soldering Purposes:
260°C Max. for 10 Seconds

MAXIMUM RATINGS

Rating	Symbol	Value	Unit
Peak Repetitive Reverse Voltage	V_{RRM}		V
Working Peak Reverse Voltage	V_{RWM}		
DC Blocking Voltage	V_R	35	
	MBR1635	45	
	MBRB1645	45	
Average Rectified Forward Current Delay (Rated V_R , $T_C = 163^\circ\text{C}$) Total Device	$I_{F(AV)}$	16	A
Peak Repetitive Forward Current, Per Leg (Rated V_R , Square Wave, 20 kHz, $T_C = 157^\circ\text{C}$) Total Device	I_{FRM}	32	A
Non-Repetitive Peak Surge Current (Surge Applied at Rated Load Conditions Halfwave, Single Phase, 60 Hz)	I_{FSM}	150	A
Peak Repetitive Reverse Surge Current (2.0 μs , 1.0 kHz)	I_{RRM}	1.0	A
Storage Temperature Range	T_{stg}	-65 to +175	°C
Operating Junction Temperature (Note 1)	T_J	-65 to +175	°C
Voltage Rate of Change (Rated V_R)	dv/dt	10,000	V/ μs

Stresses exceeding Maximum Ratings may damage the device. Maximum Ratings are stress ratings only. Functional operation above the Recommended Operating Conditions is not implied. Extended exposure to stresses above the Recommended Operating Conditions may affect device reliability.

1. The heat generated must be less than the thermal conductivity from Junction-to-Ambient: $dP_J/dT_J < 1/R_{\theta JA}$.



ON Semiconductor®

<http://onsemi.com>

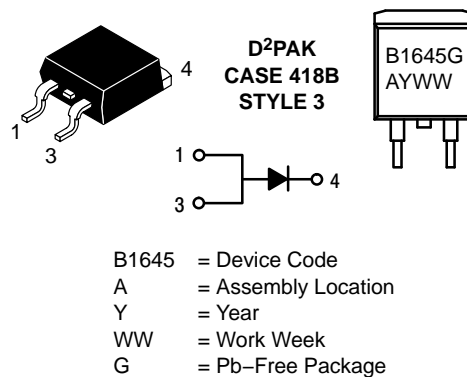
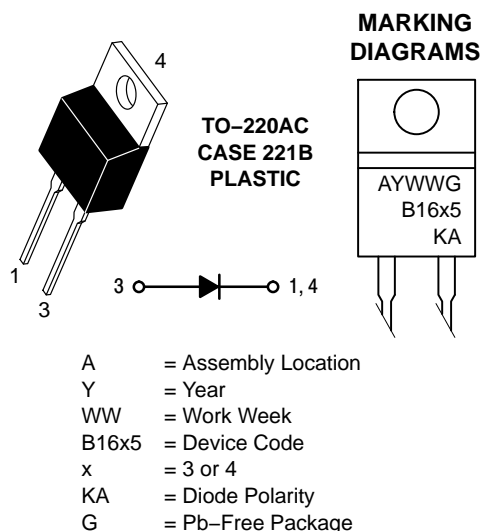

ORDERING INFORMATION

Device	Package	Shipping
MBR1635G	TO-220 (Pb-Free)	50 Units / Rail
MBR1645G	TO-220 (Pb-Free)	50 Units / Rail
MBRB1645T4G	D ² PAK (Pb-Free)	800 Units / Rail
NRVBB1645T4G	D ² PAK (Pb-Free)	800 Units / Rail

MBR1635, MBR1645, MBRB1645, NRVBB1645

THERMAL CHARACTERISTICS

Characteristic	Symbol	Value	Unit
Maximum Thermal Resistance, Junction-to-Case	$R_{\theta JC}$	1.5	$^{\circ}\text{C}/\text{W}$

ELECTRICAL CHARACTERISTICS

Characteristic	Symbol	Value	Unit
Maximum Instantaneous Forward Voltage (Note 2) ($i_F = 16$ Amps, $T_C = 125^{\circ}\text{C}$) ($i_F = 16$ Amps, $T_C = 25^{\circ}\text{C}$)	V_F	0.57 0.63	V
Maximum Instantaneous Reverse Current (Note 2) (Rated dc Voltage, $T_C = 125^{\circ}\text{C}$) (Rated dc Voltage, $T_C = 25^{\circ}\text{C}$)	i_R	40 0.2	mA

2. Pulse Test: Pulse Width = 300 μs , Duty Cycle $\leq 2.0\%$.

MBR1635, MBR1645, MBRB1645, NRVBB1645

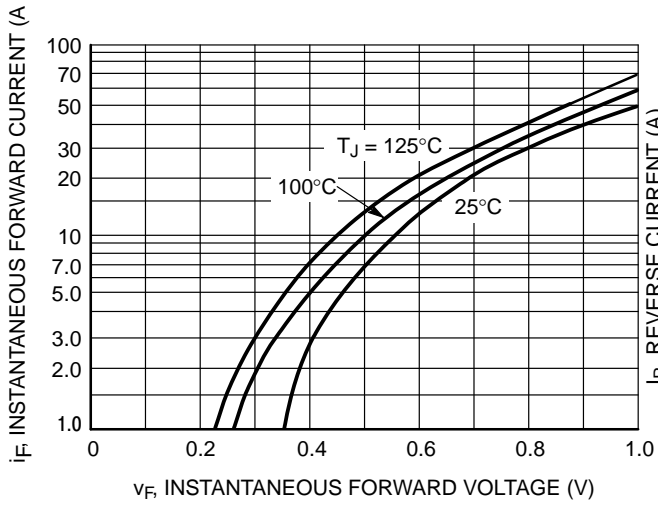

Figure 1. Typical Forward Voltage

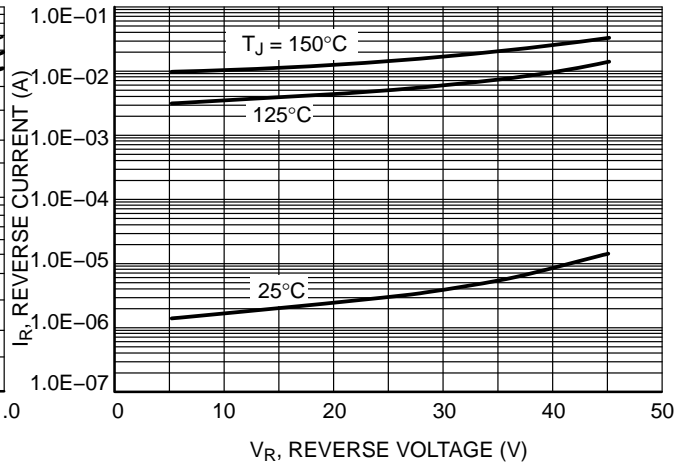

Figure 2. Typical Reverse Current

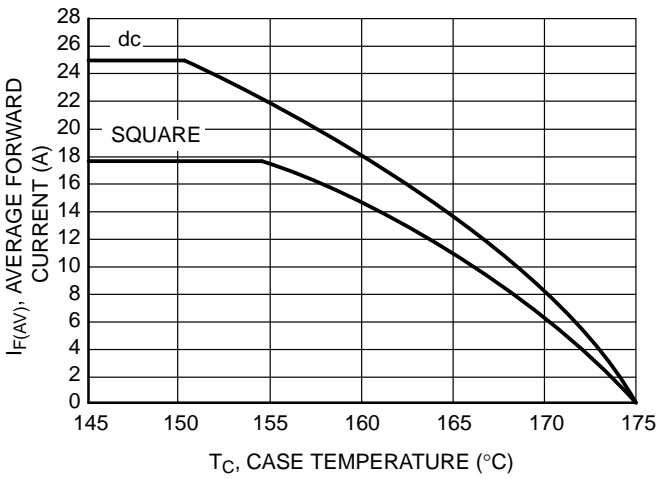

Figure 3. Current Derating, Case, Per Leg

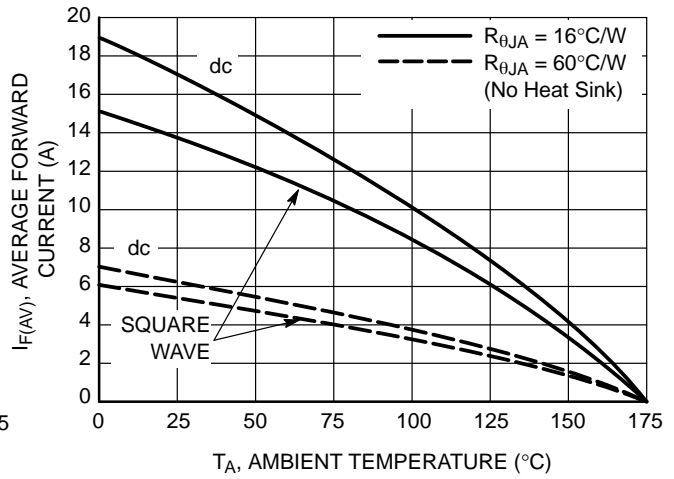

Figure 4. Current Derating, Ambient

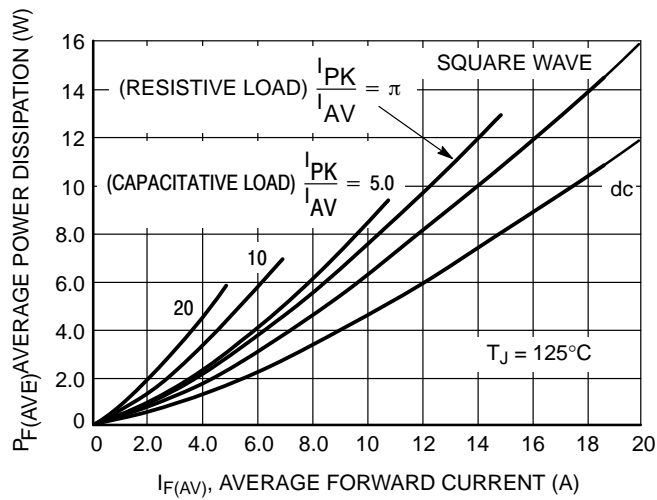

Figure 5. Forward Power Dissipation

MECHANICAL CASE OUTLINE

PACKAGE DIMENSIONS



TO-220, 2-LEAD CASE 221B-04 ISSUE F

DATE 12 APR 2013

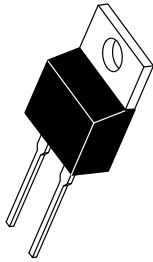

SCALE 1:1

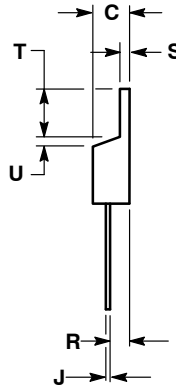
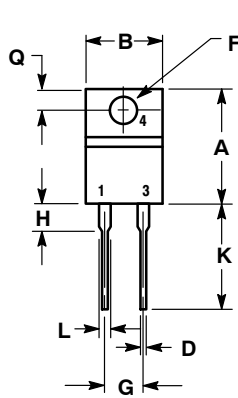

NOTES:

1. DIMENSIONING AND TOLERANCING PER ANSI Y14.5M, 1982.
2. CONTROLLING DIMENSION: INCH.

DIM	INCHES		MILLIMETERS	
	MIN	MAX	MIN	MAX
A	0.595	0.620	15.11	15.75
B	0.380	0.405	9.65	10.29
C	0.160	0.190	4.06	4.82
D	0.025	0.039	0.64	1.00
F	0.142	0.161	3.61	4.09
G	0.190	0.210	4.83	5.33
H	0.110	0.130	2.79	3.30
J	0.014	0.025	0.36	0.64
K	0.500	0.562	12.70	14.27
L	0.045	0.060	1.14	1.52
Q	0.100	0.120	2.54	3.04
R	0.080	0.110	2.04	2.79
S	0.045	0.055	1.14	1.39
T	0.235	0.255	5.97	6.48
U	0.000	0.050	0.000	1.27

STYLE 1:
PIN 1. CATHODE
2. N/A
3. ANODE
4. CATHODE

STYLE 2:
PIN 1. ANODE
2. N/A
3. CATHODE
4. ANODE

DOCUMENT NUMBER:	98ASB42149B	Electronic versions are uncontrolled except when accessed directly from the Document Repository. Printed versions are uncontrolled except when stamped "CONTROLLED COPY" in red.
DESCRIPTION:	TO-220, 2-LEAD	PAGE 1 OF 1

ON Semiconductor and are trademarks of Semiconductor Components Industries, LLC dba ON Semiconductor or its subsidiaries in the United States and/or other countries. ON Semiconductor reserves the right to make changes without further notice to any products herein. ON Semiconductor makes no warranty, representation or guarantee regarding the suitability of its products for any particular purpose, nor does ON Semiconductor assume any liability arising out of the application or use of any product or circuit, and specifically disclaims any and all liability, including without limitation special, consequential or incidental damages. ON Semiconductor does not convey any license under its patent rights nor the rights of others.

MECHANICAL CASE OUTLINE

PACKAGE DIMENSIONS

ON Semiconductor®

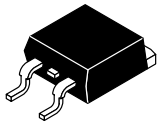

D²PAK 3
CASE 418B-04
ISSUE L

DATE 17 FEB 2015

SCALE 1:1

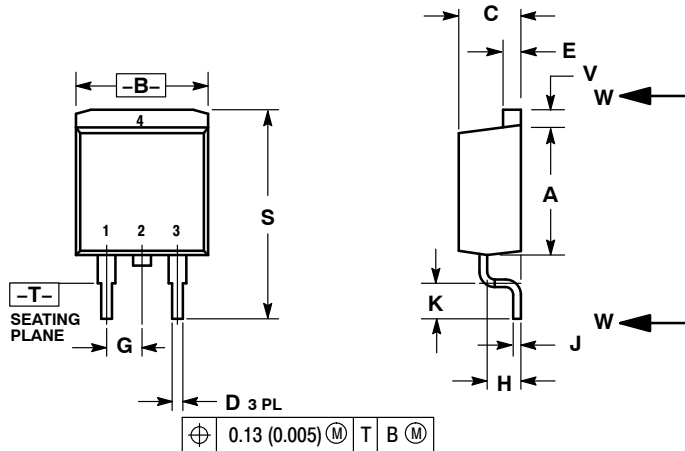

NOTES:

1. DIMENSIONING AND TOLERANCING PER ANSI Y14.5M, 1982.
2. CONTROLLING DIMENSION: INCH.
3. 418B-01 THRU 418B-03 OBSOLETE, NEW STANDARD 418B-04.

DIM	INCHES		MILLIMETERS	
	MIN	MAX	MIN	MAX
A	0.340	0.380	8.64	9.65
B	0.380	0.405	9.65	10.29
C	0.160	0.190	4.06	4.83
D	0.020	0.035	0.51	0.89
E	0.045	0.055	1.14	1.40
F	0.310	0.350	7.87	8.89
G	0.100	BSC	2.54	BSC
H	0.080	0.110	2.03	2.79
J	0.018	0.025	0.46	0.64
K	0.090	0.110	2.29	2.79
L	0.052	0.072	1.32	1.83
M	0.280	0.320	7.11	8.13
N	0.197	REF	5.00	REF
P	0.079	REF	2.00	REF
R	0.039	REF	0.99	REF
S	0.575	0.625	14.60	15.88
V	0.045	0.055	1.14	1.40

VARIABLE CONFIGURATION ZONE

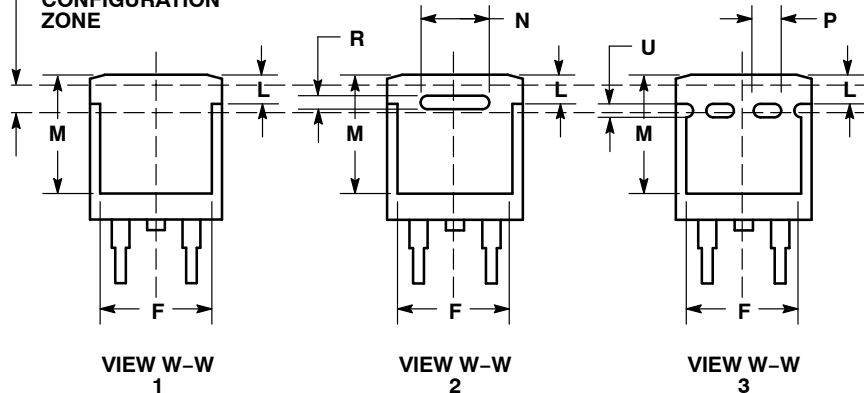

- | | | | | | |
|--|---|---|--|---|--|
| STYLE 1:
PIN 1. BASE
2. COLLECTOR
3. EMITTER
4. COLLECTOR | STYLE 2:
PIN 1. GATE
2. DRAIN
3. SOURCE
4. DRAIN | STYLE 3:
PIN 1. ANODE
2. CATHODE
3. ANODE
4. CATHODE | STYLE 4:
PIN 1. GATE
2. COLLECTOR
3. EMITTER
4. COLLECTOR | STYLE 5:
PIN 1. CATHODE
2. ANODE
3. CATHODE
4. ANODE | STYLE 6:
PIN 1. NO CONNECT
2. CATHODE
3. ANODE
4. CATHODE |
|--|---|---|--|---|--|

MARKING INFORMATION AND FOOTPRINT ON PAGE 2

DOCUMENT NUMBER:	98ASB42761B	Electronic versions are uncontrolled except when accessed directly from the Document Repository. Printed versions are uncontrolled except when stamped "CONTROLLED COPY" in red.
DESCRIPTION:	D²PAK 3	PAGE 1 OF 2

ON Semiconductor and are trademarks of Semiconductor Components Industries, LLC dba ON Semiconductor or its subsidiaries in the United States and/or other countries. ON Semiconductor reserves the right to make changes without further notice to any products herein. ON Semiconductor makes no warranty, representation or guarantee regarding the suitability of its products for any particular purpose, nor does ON Semiconductor assume any liability arising out of the application or use of any product or circuit, and specifically disclaims any and all liability, including without limitation special, consequential or incidental damages. ON Semiconductor does not convey any license under its patent rights nor the rights of others.

D²PAK 3
CASE 418B-04
ISSUE L

DATE 17 FEB 2015

**GENERIC
MARKING DIAGRAM***

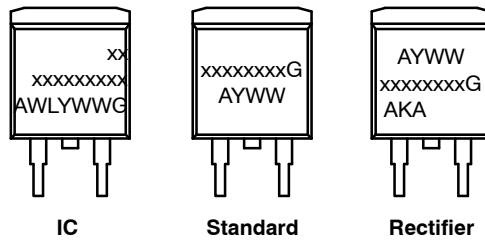

- xx = Specific Device Code
- A = Assembly Location
- WL = Wafer Lot
- Y = Year
- WW = Work Week
- G = Pb-Free Package
- AKA = Polarity Indicator

*This information is generic. Please refer to device data sheet for actual part marking. Pb-Free indicator, "G" or microdot "▪", may or may not be present.

SOLDERING FOOTPRINT*

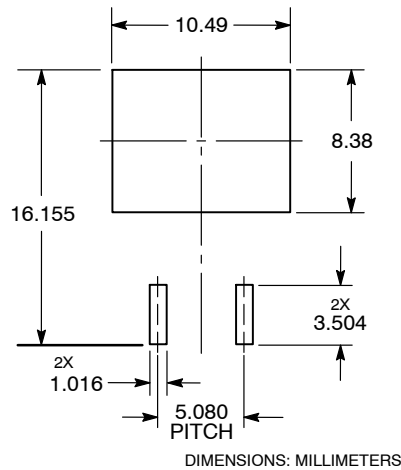

*For additional information on our Pb-Free strategy and soldering details, please download the ON Semiconductor Soldering and Mounting Techniques Reference Manual, SOLDERRM/D.

DOCUMENT NUMBER:	98ASB42761B	Electronic versions are uncontrolled except when accessed directly from the Document Repository. Printed versions are uncontrolled except when stamped "CONTROLLED COPY" in red.
DESCRIPTION:	D²PAK 3	PAGE 2 OF 2

ON Semiconductor and are trademarks of Semiconductor Components Industries, LLC dba ON Semiconductor or its subsidiaries in the United States and/or other countries. ON Semiconductor reserves the right to make changes without further notice to any products herein. ON Semiconductor makes no warranty, representation or guarantee regarding the suitability of its products for any particular purpose, nor does ON Semiconductor assume any liability arising out of the application or use of any product or circuit, and specifically disclaims any and all liability, including without limitation special, consequential or incidental damages. ON Semiconductor does not convey any license under its patent rights nor the rights of others.

onsemi, **Onsemi**, and other names, marks, and brands are registered and/or common law trademarks of Semiconductor Components Industries, LLC dba "**onsemi**" or its affiliates and/or subsidiaries in the United States and/or other countries. **onsemi** owns the rights to a number of patents, trademarks, copyrights, trade secrets, and other intellectual property. A listing of **onsemi**'s product/patent coverage may be accessed at www.onsemi.com/site/pdf/Patent-Marking.pdf. **onsemi** reserves the right to make changes at any time to any products or information herein, without notice. The information herein is provided "as-is" and **onsemi** makes no warranty, representation or guarantee regarding the accuracy of the information, product features, availability, functionality, or suitability of its products for any particular purpose, nor does **onsemi** assume any liability arising out of the application or use of any product or circuit, and specifically disclaims any and all liability, including without limitation special, consequential or incidental damages. Buyer is responsible for its products and applications using **onsemi** products, including compliance with all laws, regulations and safety requirements or standards, regardless of any support or applications information provided by **onsemi**. "Typical" parameters which may be provided in **onsemi** data sheets and/or specifications can and do vary in different applications and actual performance may vary over time. All operating parameters, including "Typicals" must be validated for each customer application by customer's technical experts. **onsemi** does not convey any license under any of its intellectual property rights nor the rights of others. **onsemi** products are not designed, intended, or authorized for use as a critical component in life support systems or any FDA Class 3 medical devices or medical devices with a same or similar classification in a foreign jurisdiction or any devices intended for implantation in the human body. Should Buyer purchase or use **onsemi** products for any such unintended or unauthorized application, Buyer shall indemnify and hold **onsemi** and its officers, employees, subsidiaries, affiliates, and distributors harmless against all claims, costs, damages, and expenses, and reasonable attorney fees arising out of, directly or indirectly, any claim of personal injury or death associated with such unintended or unauthorized use, even if such claim alleges that **onsemi** was negligent regarding the design or manufacture of the part. **onsemi** is an Equal Opportunity/Affirmative Action Employer. This literature is subject to all applicable copyright laws and is not for resale in any manner.

ADDITIONAL INFORMATION

TECHNICAL PUBLICATIONS:

Technical Library: www.onsemi.com/design/resources/technical-documentation
onsemi Website: www.onsemi.com

ONLINE SUPPORT: www.onsemi.com/support

For additional information, please contact your local Sales Representative at www.onsemi.com/support/sales