

SMDJ-HR Series

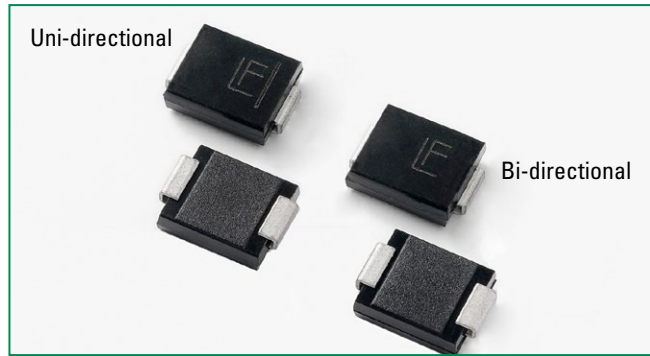

Agency Approvals

AGENCY	Agency Recognition
	E230531

Maximum Ratings and Thermal Characteristics (T_A=25°C unless otherwise noted)

Parameter	Symbol	Value	Unit
Peak Pulse Power Dissipation by 10/1000µs waveform (Note 1), (Note 2)	P _{PPM}	3000	W
Power Dissipation on infinite heat sink at T _L =50°C	P _D	6.5	W
Peak Forward Surge Current, 8.3ms Single Half Sine Wave (Note 3)	I _{FSM}	300	A
Maximum Instantaneous Forward Voltage at 100A for Unidirectional only	V _F	3.5	V
Operating Junction and Storage Temperature Range	T _J , T _{STG}	-65 to 150	°C
Typical Thermal Resistance Junction to Lead	R _{θJL}	15	°C/W
Typical Thermal Resistance Junction to Ambient	R _{θJA}	75	°C/W

Notes:

1. Non-repetitive current pulse per Fig. 2 and derated above T_A = 25°C per Fig. 3.
2. Mounted on copper pad area of 0.31x0.31" (8.0 x 8.0mm) to each terminal.
3. Measured on 8.3ms single half sine wave or equivalent square wave for unidirectional component only, duty cycle=4 per minute maximum.

Functional Diagram

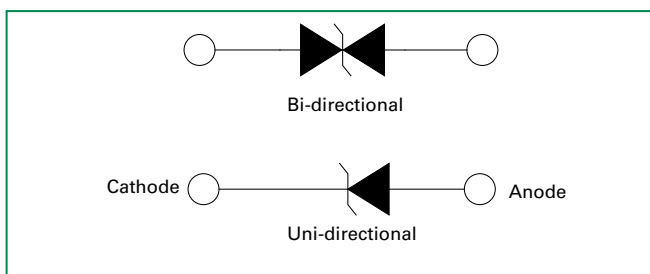

Description

The SMDJ-HR High Reliability series is designed specifically to protect sensitive electronic equipment from voltage transients induced by lightning and other transient voltage events.

Features

- 3000W peak pulse power capability at 10/1000µs waveform, repetition rate (duty cycles):0.01%
- For surface mounted applications in order to optimize board space
- Low profile package
- Built-in strain relief
- V_{BR} @ T_J = V_{BR} @ 25°C x (1 + αT x (T_J - 25)) (αT: Temperature Coefficient, typical value is 0.1%)
- Glass passivated chip junction
- Fast response time: typically less than 1.0ps from 0V to V_{BR} min
- Excellent clamping capability
- Low incremental surge resistance
- Typical I_R ≤ 2µA for V_R > 10V
- Meet MSL level1, per J-STD-020, LF maximum peak of 260°C
- UL Recognized compound meeting flammability rating V-0.
- Matte tin lead-free plated
- Halogen free and RoHS compliant
- Pb-free E3 means 2nd level interconnect is Pb-free and the terminal finish material is tin(Sn) (IPC/ JEDEC J-STD-609A.01)

Applications

TVS components are ideal for the protection of I/O Interfaces, V_{CC} bus and other vulnerable circuits used in Telecom, Computer, Industrial and Consumer electronic applications.

Electrical Characteristics

Part Number (Uni)	Part Number (Bi)	Marking		Reverse Stand off Voltage V_R (Volts)	Breakdown Voltage V_{BR} (Volts) @ I_T		Test Current I_T (mA)	Maximum Clamping Voltage V_C @ I_{pp} (V)	Maximum Peak Pulse Current I_{pp} (A)	Maximum Reverse Leakage I_R @ V_R (μ A)	Agency Approval 
		UNI	BI		MIN	MAX					
SMDJ5.0A-HR	SMDJ5.0CA-HR	RDE	DDE	5.0	6.40	7.00	10	9.2	326.1	800	X
SMDJ6.0A-HR	SMDJ6.0CA-HR	RDG	DDG	6.0	6.67	7.37	10	10.3	291.3	800	X
SMDJ6.5A-HR	SMDJ6.5CA-HR	RDK	DDK	6.5	7.22	7.98	10	11.2	267.9	500	X
SMDJ7.0A-HR	SMDJ7.0CA-HR	PDM	DDM	7.0	7.78	8.60	10	12.0	250.0	200	X
SMDJ7.5A-HR	SMDJ7.5CA-HR	PDP	DDP	7.5	8.33	9.21	1	12.9	232.6	100	X
SMDJ8.0A-HR	SMDJ8.0CA-HR	PDR	DDR	8.0	8.89	9.83	1	13.6	220.6	50	X
SMDJ8.5A-HR	SMDJ8.5CA-HR	PDT	DDT	8.5	9.44	10.40	1	14.4	208.3	20	X
SMDJ9.0A-HR	SMDJ9.0CA-HR	PDV	DDV	9.0	10.00	11.10	1	15.4	194.8	10	X
SMDJ10A-HR	SMDJ10CA-HR	PDX	DDX	10.0	11.10	12.30	1	17.0	176.5	5	X
SMDJ11A-HR	SMDJ11CA-HR	PDZ	DDZ	11.0	12.20	13.50	1	18.2	164.8	2	X
SMDJ12A-HR	SMDJ12CA-HR	PEE	DEE	12.0	13.30	14.70	1	19.9	150.8	2	X
SMDJ13A-HR	SMDJ13CA-HR	PEG	DEG	13.0	14.40	15.90	1	21.5	139.5	2	X
SMDJ14A-HR	SMDJ14CA-HR	PEK	DEK	14.0	15.60	17.20	1	23.2	129.3	2	X
SMDJ15A-HR	SMDJ15CA-HR	PEM	DEM	15.0	16.70	18.50	1	24.4	123.0	2	X
SMDJ16A-HR	SMDJ16CA-HR	PEP	DEP	16.0	17.80	19.70	1	26.0	115.4	2	X
SMDJ17A-HR	SMDJ17CA-HR	PER	DER	17.0	18.90	20.90	1	27.6	108.7	2	X
SMDJ18A-HR	SMDJ18CA-HR	PET	DET	18.0	20.00	22.10	1	29.2	102.7	2	X
SMDJ20A-HR	SMDJ20CA-HR	PEV	DEV	20.0	22.20	24.50	1	32.4	92.6	2	X
SMDJ22A-HR	SMDJ22CA-HR	PEX	DEX	22.0	24.40	26.90	1	35.5	84.5	2	X
SMDJ24A-HR	SMDJ24CA-HR	PEZ	DEZ	24.0	26.70	29.50	1	38.9	77.1	2	X
SMDJ26A-HR	SMDJ26CA-HR	PFE	DFE	26.0	28.90	31.90	1	42.1	71.3	2	X
SMDJ28A-HR	SMDJ28CA-HR	PFG	DFG	28.0	31.10	34.40	1	45.4	66.1	2	X
SMDJ30A-HR	SMDJ30CA-HR	PFK	DFK	30.0	33.30	36.80	1	48.4	62.0	2	X
SMDJ33A-HR	SMDJ33CA-HR	PFM	DFM	33.0	36.70	40.60	1	53.3	56.3	2	X
SMDJ36A-HR	SMDJ36CA-HR	PFP	DFP	36.0	40.00	44.20	1	58.1	51.6	2	X
SMDJ40A-HR	SMDJ40CA-HR	PFR	DFR	40.0	44.40	49.10	1	64.5	46.5	2	X
SMDJ43A-HR	SMDJ43CA-HR	PFT	DFT	43.0	47.80	52.80	1	69.4	43.2	2	X
SMDJ45A-HR	SMDJ45CA-HR	PFV	DFV	45.0	50.00	55.30	1	72.7	41.3	2	X
SMDJ48A-HR	SMDJ48CA-HR	PFX	DFX	48.0	53.30	58.90	1	77.4	38.8	2	X
SMDJ51A-HR	SMDJ51CA-HR	PFZ	DFZ	51.0	56.70	62.70	1	82.4	36.4	2	X
SMDJ54A-HR	SMDJ54CA-HR	RGE	DGE	54.0	60.00	66.30	1	87.1	34.4	2	X
SMDJ58A-HR	-	PGG	-	58.0	64.40	71.20	1	93.6	32.1	2	X
SMDJ60A-HR	-	PGK	-	60.0	66.70	73.70	1	96.8	31.0	2	X
SMDJ64A-HR	-	PGM	-	64.0	71.10	78.60	1	103.0	29.1	2	X
SMDJ70A-HR	-	PGP	-	70.0	77.80	86.00	1	113.0	26.5	2	X
SMDJ75A-HR	-	PGR	-	75.0	83.30	92.10	1	121.0	24.8	2	X
SMDJ78A-HR	-	PGT	-	78.0	86.70	95.80	1	126.0	23.8	2	X
SMDJ85A-HR	-	PGV	-	85.0	94.40	104.00	1	137.0	21.9	2	X
SMDJ90A-HR	-	PGX	-	90.0	100.00	111.00	1	146.0	20.5	2	X
SMDJ100A-HR	-	PGZ	-	100.0	111.00	123.00	1	162.0	18.5	2	X
SMDJ110A-HR	-	PHE	-	110.0	122.00	135.00	1	177.0	16.9	2	X
SMDJ120A-HR	-	PHG	-	120.0	133.00	147.00	1	193.0	15.5	2	X
SMDJ130A-HR	-	PHK	-	130.0	144.00	159.00	1	209.0	14.4	2	X
SMDJ150A-HR	-	PHM	-	150.0	167.00	185.00	1	243.0	12.3	2	X

Note:

1. For bidirectional type having V_R of 10 volts and less, the I_R limit is double.
2. Each lot of parts will pass group B test requirements.

Screen Process

100% Vision Inspection	MIL-STD-750 method 2074
100% High Temperature Storage Life (168hrs,175°C)	MIL-STD-750 method 1031
100% X-RAY inspection	MIL-STD-750 method 2076
100% Temperature Cycle Test (-55 to150°C, 20 cycles, dwell time 15 min)	MIL-STD-750 method 1051
100% Reflow (2X)	JEDEC J-STD-020
100% Surge Test (2x)	MIL-STD-750 method 4066
100% HTRB 150°C Bias=VR(80% breakdown voltage, 96hrs, and each direction 96hrs for Bi-directional products)	MIL-STD-750 method 1038
Final Electrical Test(100% 3 sigma limit, 100% dynamic test and PAT limit)	MIL-STD-750 method 4016.4021.4011

Note: Up-screen program can be specified by customer's request via contacting Littelfuse service

Group B Test Requirements

Screen	Method	Condition	Requirement
Surge test	10/1000 μ s Peak Pulse Waveform	Maximum clamping Voltage (V_C) @ Peak Pulse Current (I_{pp})	Sample Size 45 perform 10x Accept 0 failures
Burn - In (HTRB)	MIL-STD-750, Method 1038.5	Applied voltage 100% V_R @150°C	Sample size 45 340 hours (680 hours for bi-direction products, each direction 340 hours) Accept 0 failures
Electrical test	--	I_R @ V_R , V_{BR} @ I_T	Sample size 45 Accept 0 failures

I-V Curve Characteristics

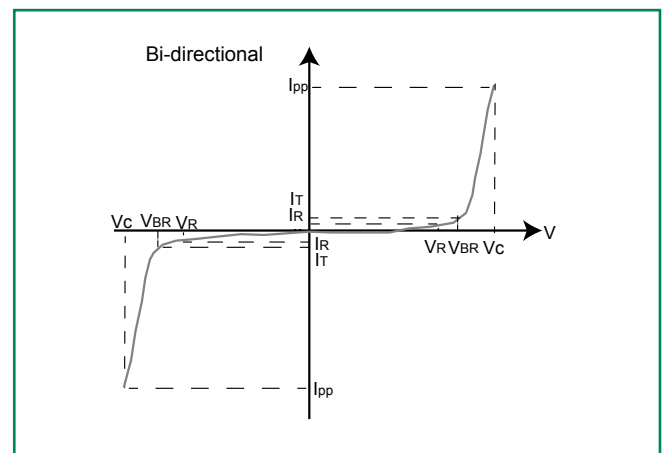
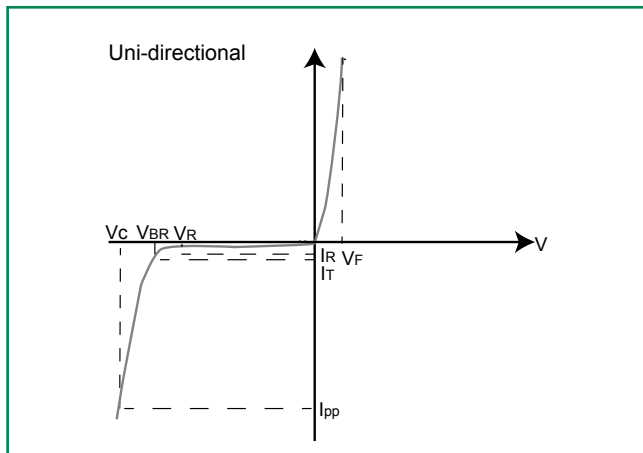

P_{PPM} Peak Pulse Power Dissipation – Max power dissipation

V_R Stand-off Voltage – Maximum voltage that can be applied to the TVS without operation

V_{BR} Breakdown Voltage – Maximum voltage that flows through the TVS at a specified test current (I_T)

V_C Clamping Voltage – Peak voltage measured across the suppressor at a specified I_{ppm} (peak impulse current)

I_R Reverse Leakage Current – Current measured at V_R

V_F Forward Voltage Drop for Uni-directional

Ratings and Characteristic Curves ($T_A = 25^\circ\text{C}$ unless otherwise noted)

Figure 1 - TVS Transients Clamping Waveform

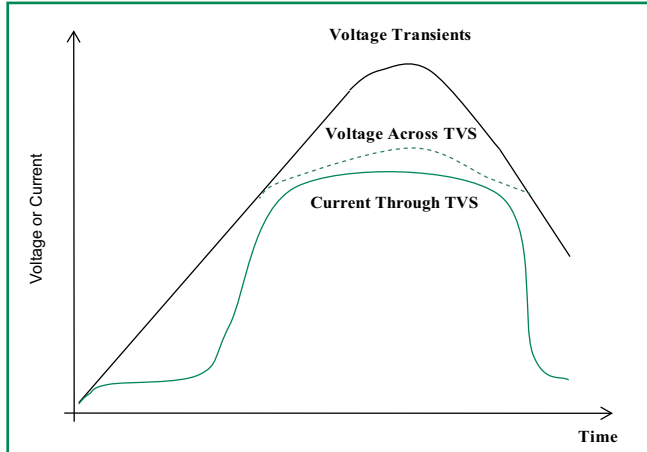

Figure 2 - Peak Pulse Power Rating

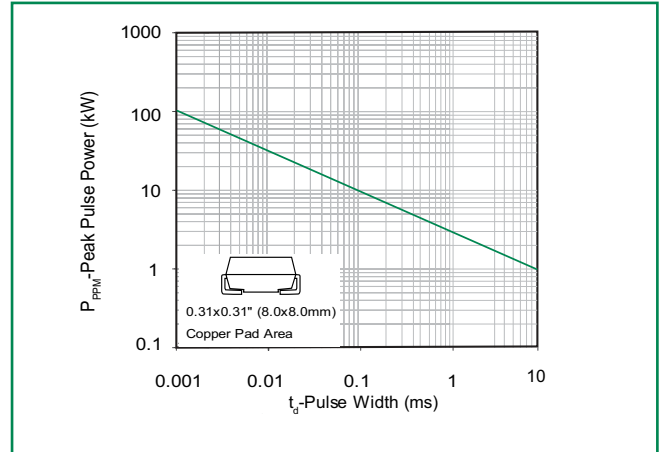

Figure 3 - Pulse Derating Curve

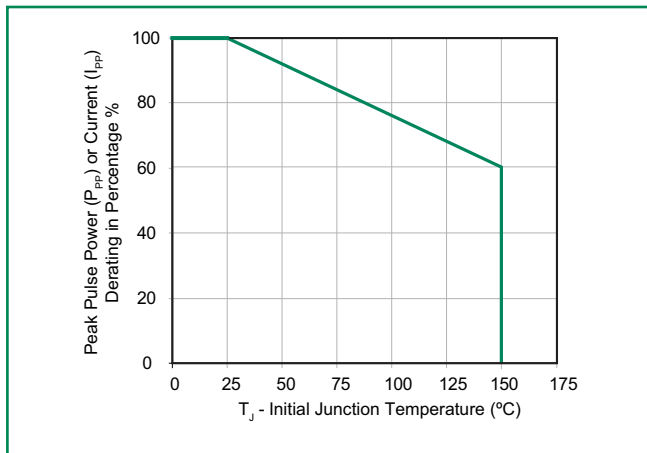

Figure 4 - Pulse Waveform

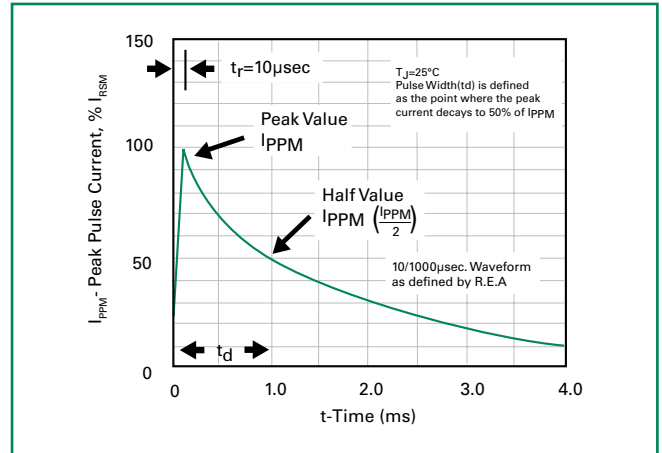

Figure 5 - Typical Junction Capacitance

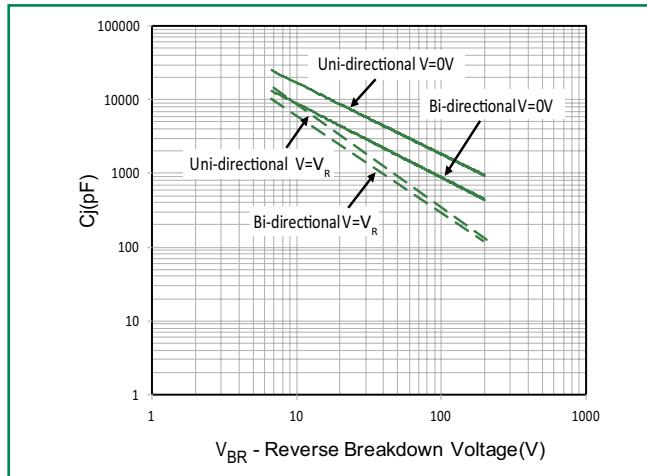

Figure 6 - Steady State Power Derating Curve

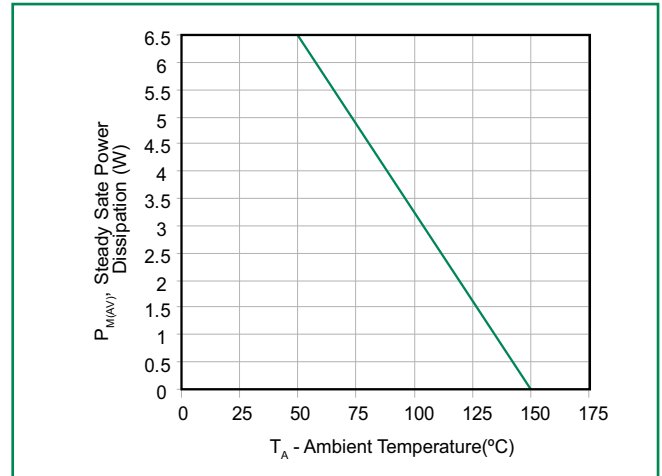
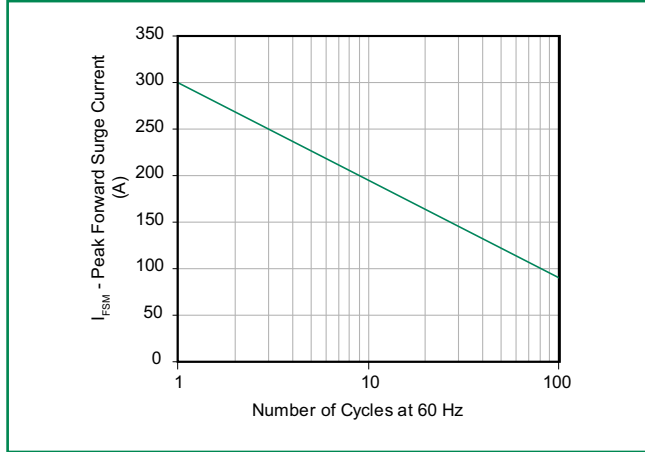
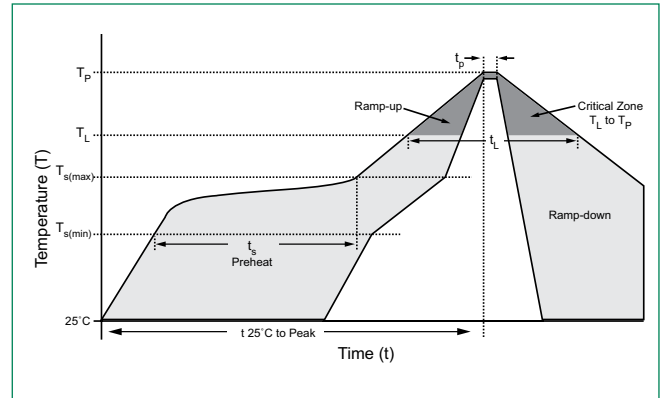

Figure 7 - Maximum Non-Repetitive Peak Forward Surge Current Uni-Directional only



Soldering Parameters

Reflow Condition		Lead-free assembly
Pre Heat	- Temperature Min ($T_{s(min)}$)	150°C
	- Temperature Max ($T_{s(max)}$)	200°C
	- Time (min to max) (t_s)	60 – 180 secs
Average ramp up rate (Liquidus Temp (T_L) to peak)		3°C/second max
$T_{s(max)}$ to T_L - Ramp-up Rate		3°C/second max
Reflow	- Temperature (T_L) (Liquidus)	217°C
	- Time (min to max) (t_s)	60 – 150 seconds
Peak Temperature (T_p)		260 ^{+0/-5} °C
Time within 5°C of actual peak Temperature (t_p)		20 – 40 seconds
Ramp-down Rate		6°C/second max
Time 25°C to peak Temperature (T_p)		8 minutes Max.
Do not exceed		260°C



Physical Specifications

Weight	0.007 ounce, 0.21 grams
Case	JEDEC DO214AB. Molded plastic body over glass passivated junction
Polarity	Color band denotes positive end (cathode) except Bidirectional.
Terminal	Matte Tin-plated leads, Solderable per JESD22-B102

Environmental Specifications

High Temp. Storage	JESD22-A103
HTRB	JESD22-A108
Thermal Shock	JESD22-A106
MSL	JEDEC-J-STD-020, Level 1
H3TRB	JESD22-A101
RSH	JESD22-A111

Part Numbering System

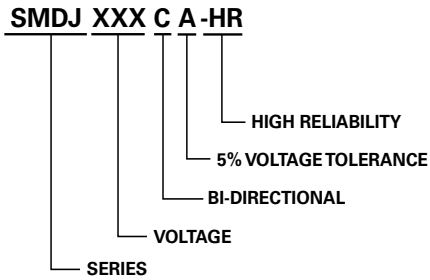

Part Marking System

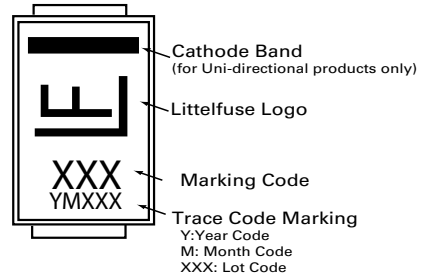

Packaging

Part number	Component Package	Quantity	Packaging Option	Packaging Specification
SMDJxxxXX-HR	DO-214AB	500	Tape & Reel – 16mm tape/7" reel	EIA STD RS-481

Dimensions

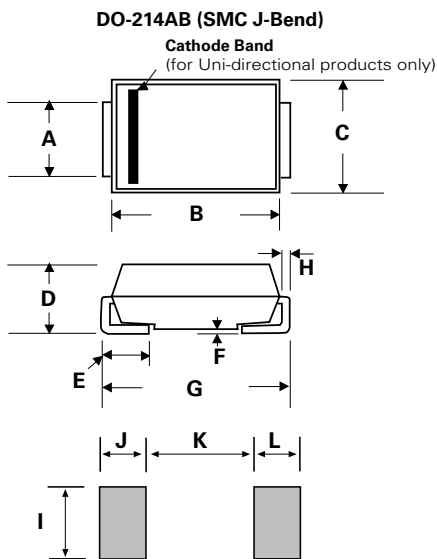

Dimensions	Inches		Millimeters	
	Min	Max	Min	Max
A	0.114	0.126	2.900	3.200
B	0.260	0.280	6.600	7.110
C	0.220	0.245	5.590	6.220
D	0.079	0.103	2.060	2.620
E	0.030	0.060	0.760	1.520
F	0.002	0.008	0.051	0.203
G	0.305	0.320	7.750	8.130
H	0.006	0.012	0.152	0.305
I	0.129	-	3.300	-
J	0.094	-	2.400	-
K	-	0.165	-	4.200
L	0.094	-	2.400	-

Tape and Reel Specification

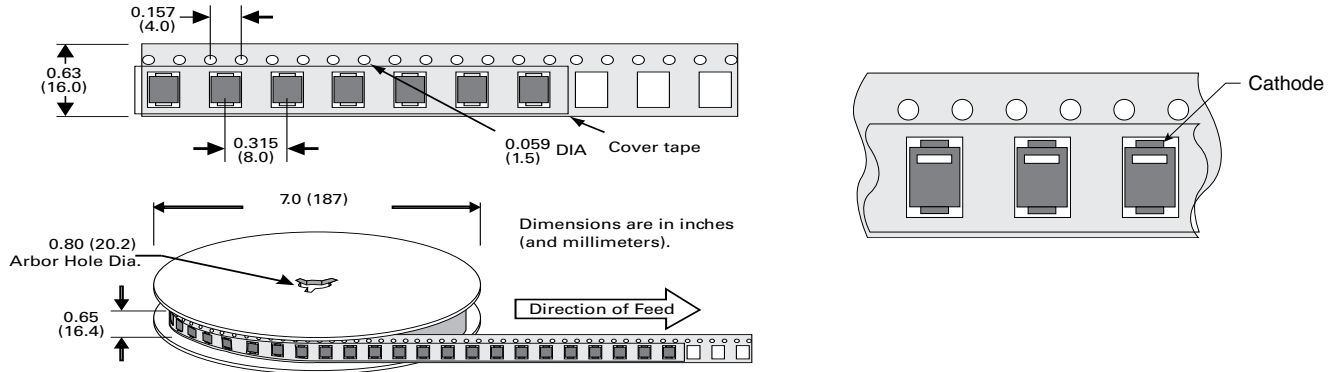

RTCA/DO-160G Wave 3

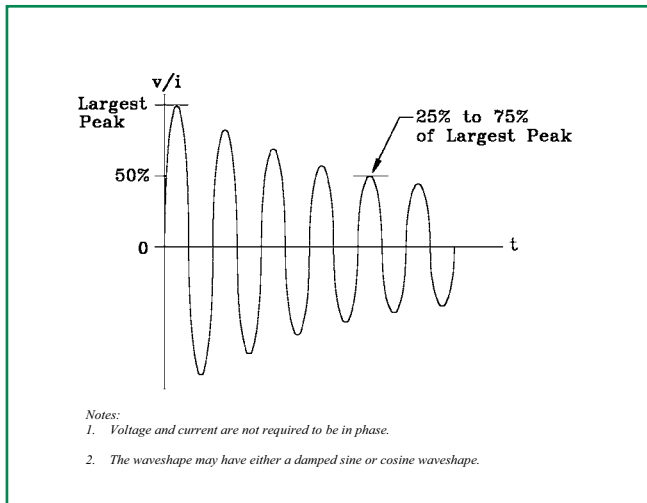

RTCA/DO-160G Wave 4

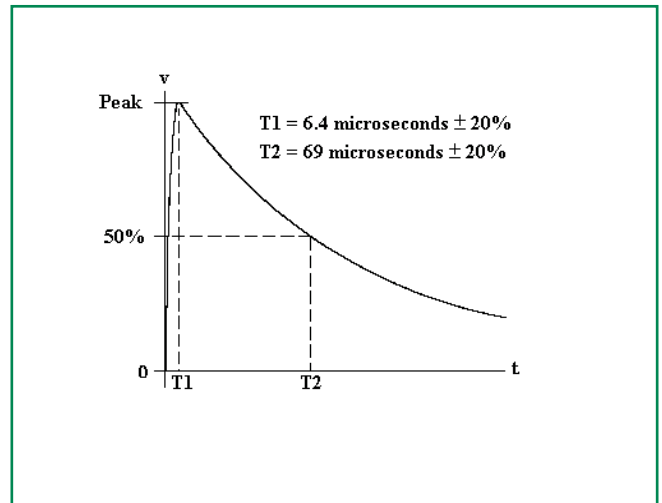

RTCA/DO-160G Wave 5

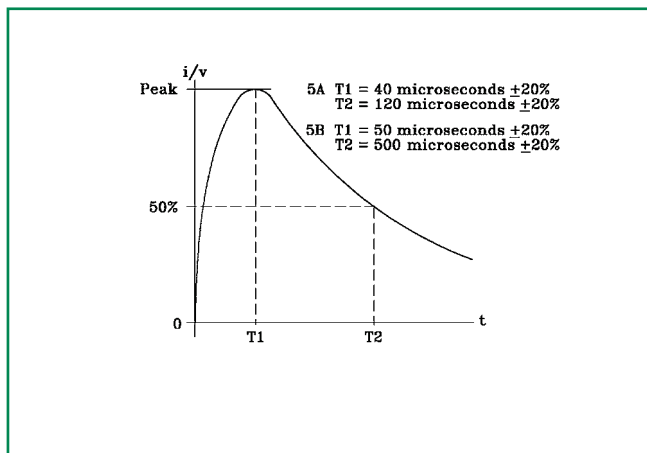

Pin Injection Protection Per RTCA/DO-160G

Part Number (Uni)	Part Number (Bi)	25C						70C						120C					
		Wave 3		Wave 4 (6.4/69us)		Wave 5a (40/120us)		Wave 3		Wave 4 (6.4/69us)		Wave 5a (40/120us)		Wave 3		Wave 4 (6.4/69us)		Wave 5a (40/120us)	
		L5	L3	L4	L5	L3	L4	L5	L3	L4	L5	L3	L4	L5	L3	L4	L5	L3	L4
		128A	60A	150A	320A	300A	750A	128A	60A	150A	320A	300A	750A	128A	60A	150A	320A	300A	750A
SMDJ5.0A-HR	SMDJ5.0CA-HR	pass	pass	pass	pass	pass	pass	pass	pass	pass	pass	pass	pass	pass	pass	pass	pass	pass	pass
SMDJ6.0A-HR	SMDJ6.0CA-HR	pass	pass	pass	pass	pass	pass	pass	pass	pass	pass	pass	pass	pass	pass	pass	pass	pass	pass
SMDJ6.5A-HR	SMDJ6.5CA-HR	pass	pass	pass	pass	pass	pass	pass	pass	pass	pass	pass	pass	pass	pass	pass	pass	pass	-
SMDJ7.0A-HR	SMDJ7.0CA-HR	pass	pass	pass	pass	pass	pass	pass	pass	pass	pass	pass	-	pass	pass	pass	pass	pass	-
SMDJ7.5A-HR	SMDJ7.5CA-HR	pass	pass	pass	pass	pass	pass	pass	pass	pass	pass	pass	-	pass	pass	pass	pass	pass	-
SMDJ8.0A-HR	SMDJ8.0CA-HR	pass	pass	pass	pass	pass	pass	pass	pass	pass	pass	pass	-	pass	pass	pass	pass	pass	-
SMDJ8.5A-HR	SMDJ8.5CA-HR	pass	pass	pass	pass	pass	pass	pass	pass	pass	pass	pass	-	pass	pass	pass	pass	pass	-
SMDJ9.0A-HR	SMDJ9.0CA-HR	pass	pass	pass	pass	pass	pass	pass	pass	pass	pass	pass	-	pass	pass	pass	pass	pass	-
SMDJ10A-HR	SMDJ10CA-HR	pass	pass	pass	pass	pass	pass	pass	pass	pass	pass	pass	-	pass	pass	pass	pass	pass	-
SMDJ11A-HR	SMDJ11CA-HR	pass	pass	pass	pass	pass	-	pass	pass	pass	pass	pass	-	pass	pass	pass	pass	-	-
SMDJ12A-HR	SMDJ12CA-HR	pass	pass	pass	pass	pass	-	pass	pass	pass	pass	pass	-	pass	pass	pass	pass	-	-
SMDJ13A-HR	SMDJ13CA-HR	pass	pass	pass	pass	pass	-	pass	pass	pass	pass	pass	-	pass	pass	pass	pass	-	-
SMDJ14A-HR	SMDJ14CA-HR	pass	pass	pass	pass	pass	-	pass	pass	pass	pass	pass	-	pass	pass	pass	pass	-	-
SMDJ15A-HR	SMDJ15CA-HR	pass	pass	pass	pass	pass	-	pass	pass	pass	pass	pass	-	pass	pass	pass	pass	-	-
SMDJ16A-HR	SMDJ16CA-HR	pass	pass	pass	pass	pass	-	pass	pass	pass	pass	-	-	pass	pass	pass	-	-	-
SMDJ17A-HR	SMDJ17CA-HR	pass	pass	pass	pass	pass	-	pass	pass	pass	pass	-	-	pass	pass	pass	-	-	-
SMDJ18A-HR	SMDJ18CA-HR	pass	pass	pass	pass	pass	-	pass	pass	pass	pass	-	-	pass	pass	pass	-	-	-
SMDJ20A-HR	SMDJ20CA-HR	pass	pass	pass	pass	pass	-	pass	pass	pass	pass	-	-	pass	pass	pass	-	-	-
SMDJ22A-HR	SMDJ22CA-HR	pass	pass	pass	-	-	-	pass	pass	pass	-	-	-	pass	pass	pass	-	-	-
SMDJ24A-HR	SMDJ24CA-HR	pass	pass	pass	-	-	-	pass	pass	pass	-	-	-	pass	pass	pass	-	-	-
SMDJ26A-HR	SMDJ26CA-HR	pass	pass	pass	-	-	-	pass	pass	pass	-	-	-	pass	pass	pass	-	-	-
SMDJ28A-HR	SMDJ28CA-HR	pass	pass	pass	-	-	-	pass	pass	pass	-	-	-	pass	pass	pass	-	-	-
SMDJ30A-HR	SMDJ30CA-HR	pass	pass	pass	-	-	-	pass	pass	pass	-	-	-	pass	pass	pass	-	-	-
SMDJ33A-HR	SMDJ33CA-HR	pass	pass	pass	-	-	-	pass	pass	pass	-	-	-	pass	pass	pass	-	-	-
SMDJ36A-HR	SMDJ36CA-HR	pass	pass	pass	-	-	-	pass	pass	pass	-	-	-	pass	pass	pass	-	-	-
SMDJ40A-HR	SMDJ40CA-HR	pass	pass	pass	-	-	-	pass	pass	pass	-	-	-	pass	pass	pass	-	-	-
SMDJ43A-HR	SMDJ43CA-HR	pass	pass	pass	-	-	-	pass	pass	pass	-	-	-	pass	pass	-	-	-	-
SMDJ45A-HR	SMDJ45CA-HR	pass	pass	pass	-	-	-	pass	pass	-	-	-	-	pass	pass	-	-	-	-
SMDJ48A-HR	SMDJ48CA-HR	pass	pass	pass	-	-	-	pass	pass	-	-	-	-	pass	pass	-	-	-	-
SMDJ51A-HR	SMDJ51CA-HR	pass	pass	pass	-	-	-	pass	pass	-	-	-	-	pass	pass	-	-	-	-
SMDJ54A-HR	SMDJ54CA-HR	pass	pass	pass	-	-	-	pass	pass	-	-	-	-	pass	pass	-	-	-	-
SMDJ58A-HR	-	pass	pass	-	-	-	-	pass	pass	-	-	-	-	pass	pass	-	-	-	-
SMDJ60A-HR	-	pass	pass	-	-	-	-	pass	pass	-	-	-	-	pass	pass	-	-	-	-
SMDJ64A-HR	-	pass	pass	-	-	-	-	pass	pass	-	-	-	-	pass	-	-	-	-	-
SMDJ70A-HR	-	pass	pass	-	-	-	-	pass	pass	-	-	-	-	pass	-	-	-	-	-
SMDJ75A-HR	-	pass	pass	-	-	-	-	pass	pass	-	-	-	-	pass	-	-	-	-	-
SMDJ78A-HR	-	pass	pass	-	-	-	-	pass	pass	-	-	-	-	pass	-	-	-	-	-
SMDJ85A-HR	-	pass	pass	-	-	-	-	pass	pass	-	-	-	-	pass	-	-	-	-	-
SMDJ90A-HR	-	pass	pass	-	-	-	-	pass	-	-	-	-	-	pass	-	-	-	-	-
SMDJ100A-HR	-	pass	pass	-	-	-	-	pass	-	-	-	-	-	pass	-	-	-	-	-
SMDJ110A-HR	-	pass	pass	-	-	-	-	pass	-	-	-	-	-	pass	-	-	-	-	-
SMDJ120A-HR	-	pass	pass	-	-	-	-	pass	-	-	-	-	-	pass	-	-	-	-	-
SMDJ130A-HR	-	pass	pass	-	-	-	-	pass	-	-	-	-	-	pass	-	-	-	-	-
SMDJ150A-HR	-	pass	pass	-	-	-	-	pass	-	-	-	-	-	pass	-	-	-	-	-

Note:

- L1 = Level 1, L2 = Level 2, L3 = Level 3, L4 = Level 4, L5 = Level 5

Disclaimer Notice - Information furnished is believed to be accurate and reliable. However, users should independently evaluate the suitability of and test each product selected for their own applications. Littelfuse products are not designed for, and may not be used in, all applications. Read complete Disclaimer Notice at <http://www.littelfuse.com/disclaimer-electronics>.