



# 5HP01M — P-Channel Silicon MOSFET

## General-Purpose Switching Device Applications

### Features

- Low ON-resistance
- Ultrahigh-speed switching
- 4V drive

### Specifications

Absolute Maximum Ratings at Ta=25°C

| Parameter                   | Symbol           | Conditions             | Ratings     | Unit |
|-----------------------------|------------------|------------------------|-------------|------|
| Drain-to-Source Voltage     | V <sub>DSS</sub> |                        | -50         | V    |
| Gate-to-Source Voltage      | V <sub>GSS</sub> |                        | ±20         | V    |
| Drain Current (DC)          | I <sub>D</sub>   |                        | -0.07       | A    |
| Drain Current (Pulse)       | I <sub>DP</sub>  | PW≤10μs, duty cycle≤1% | -0.28       | A    |
| Allowable Power Dissipation | P <sub>D</sub>   |                        | 0.15        | W    |
| Channel Temperature         | T <sub>ch</sub>  |                        | 150         | °C   |
| Storage Temperature         | T <sub>stg</sub> |                        | -55 to +150 | °C   |

This product is designed to "ESD immunity < 200V\*\*", so please take care when handling.

\* Machine Model

### Package Dimensions

unit : mm (typ)

7023A-010

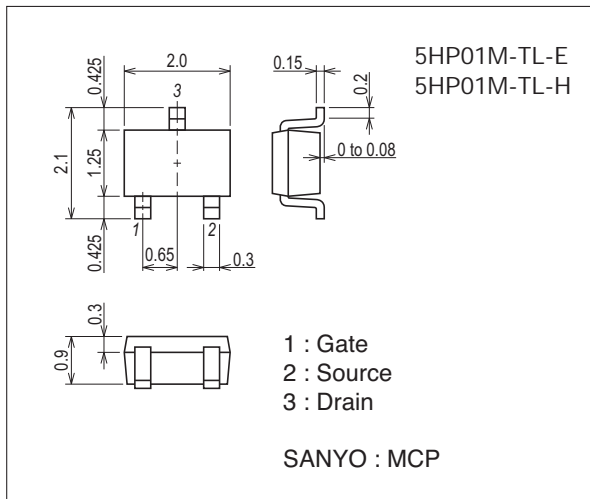

### Product & Package Information

- Package : MCP
- JEITA, JEDEC : SC-70, SOT-323
- Minimum Packing Quantity : 3,000 pcs./reel

### Packing Type: TL

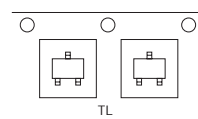

### Marking

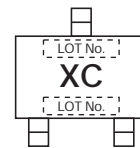

### Electrical Connection

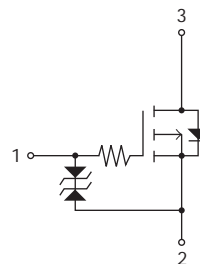

# 5HP01M

## Electrical Characteristics at Ta=25°C

| Parameter                                  | Symbol               | Conditions   | Ratings                                     |       |      | Unit |
|--|----------------------|--|---|-------|------|------|
|  |                      |  | min   | typ   | max  |      |
| Drain-to-Source Breakdown Voltage          | V(BR)DSS             | I <sub>D</sub> = -1mA, V <sub>GS</sub> =0V                             | -50   |       |      | V    |
| Zero-Gate Voltage Drain Current            | I <sub>DSS</sub>     | V <sub>DS</sub> = -50V, V <sub>GS</sub> =0V                            |   |       | -1   | μA   |
| Gate-to-Source Leakage Current             | I <sub>GSS</sub>     | V <sub>GS</sub> =±16V, V <sub>DS</sub> =0V                             |   |       | ±10  | μA   |
| Cutoff Voltage                             | V <sub>GS(off)</sub> | V <sub>DS</sub> = -10V, I <sub>D</sub> = -100μA                        | -1  |       | -2.5 | V    |
| Forward Transfer Admittance                | y <sub>fs</sub>      | V <sub>DS</sub> = -10V, I <sub>D</sub> = -40mA                         | 50  | 70    |      | mS   |
| Static Drain-to-Source On-State Resistance | R <sub>DS(on)1</sub> | I <sub>D</sub> = -40mA, V <sub>GS</sub> = -10V                         |   | 17    | 22   | Ω    |
|  | R <sub>DS(on)2</sub> | I <sub>D</sub> = -20mA, V <sub>GS</sub> = -4V                          |   | 23    | 32   | Ω    |
| Input Capacitance                          | C <sub>iss</sub>     | V <sub>DS</sub> = -10V, f=1MHz   |   | 6.2   |      | pF   |
| Output Capacitance                         | C <sub>oss</sub>     |  |   | 4.0   |      | pF   |
| Reverse Transfer Capacitance               | C <sub>rss</sub>     |  |   | 1.3   |      | pF   |
| Turn-ON Delay Time                         | t <sub>d(on)</sub>   |  |   | 13    |      | ns   |
| Rise Time                                  | t <sub>r</sub>       | See specified Test Circuit.  |   | 10    |      | ns   |
| Turn-OFF Delay Time                        | t <sub>d(off)</sub>  |  |   | 100   |      | ns   |
| Fall Time                                  | t <sub>f</sub>       |  |   | 150   |      | ns   |
| Total Gate Charge                          | Q <sub>g</sub>       |  |   | 1.32  |      | nC   |
| Gate-to-Source Charge                      | Q <sub>gs</sub>      | V <sub>DS</sub> = -10V, V <sub>GS</sub> = -10V, I <sub>D</sub> = -70mA |   | 0.17  |      | nC   |
| Gate-to-Drain "Miller" Charge              | Q <sub>gd</sub>      |  |   | 0.34  |      | nC   |
| Diode Forward Voltage                      | V <sub>SD</sub>      |  | I <sub>S</sub> = -70mA, V <sub>GS</sub> =0V | -0.85 | -1.2 |      |

## Switching Time Test Circuit

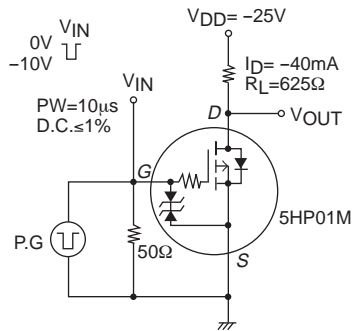

## Ordering Information

| Device      | Package | Shipping       | memo                     |
|-------------|---------|----------------|--------------------------|
| 5HP01M-TL-E | MCP     | 3,000pcs./reel | Pb Free                  |
| 5HP01M-TL-H | MCP     | 3,000pcs./reel | Pb Free and Halogen Free |

# 5HP01M

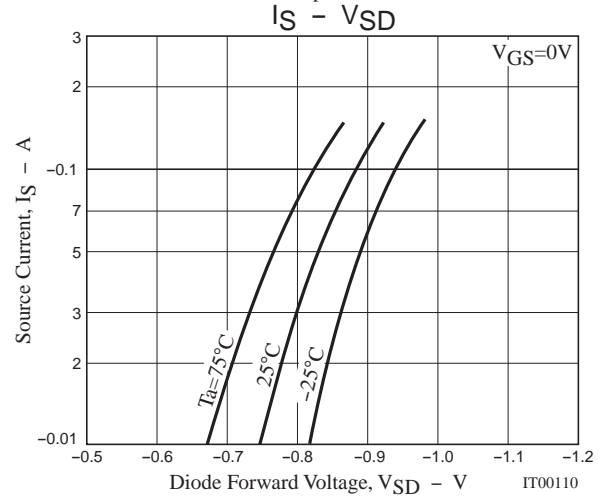
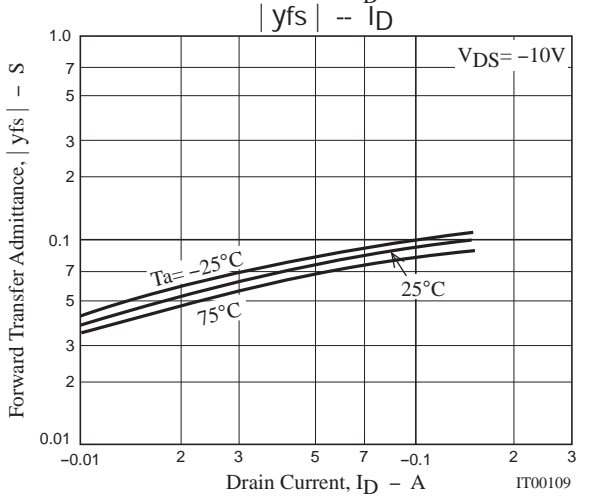
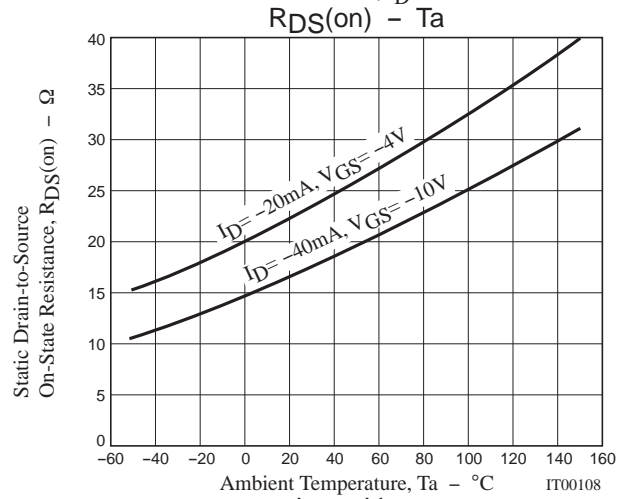
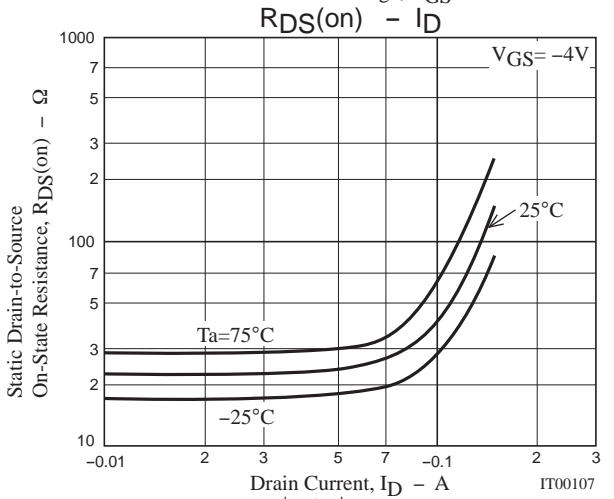
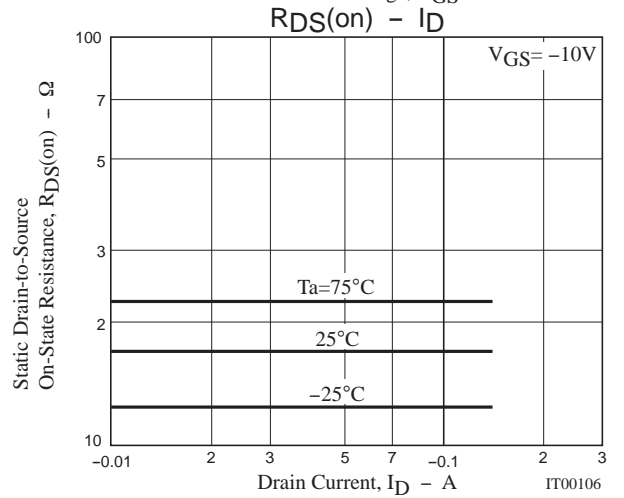
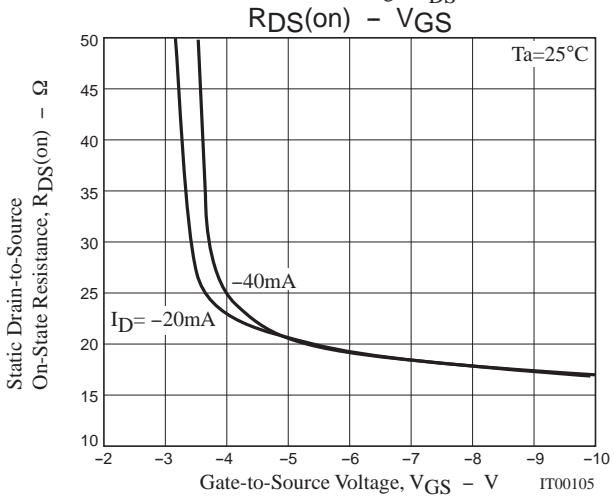
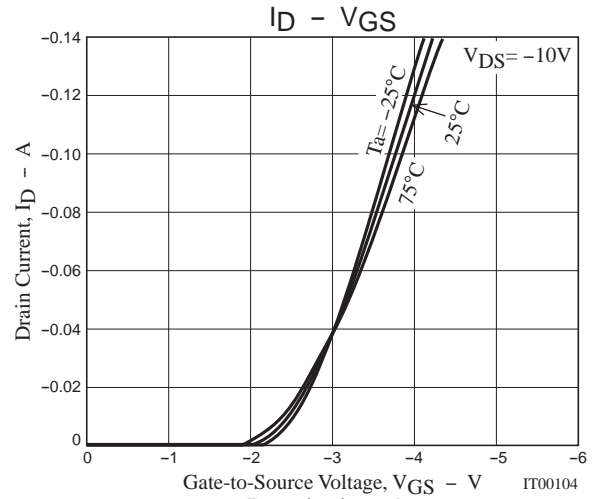
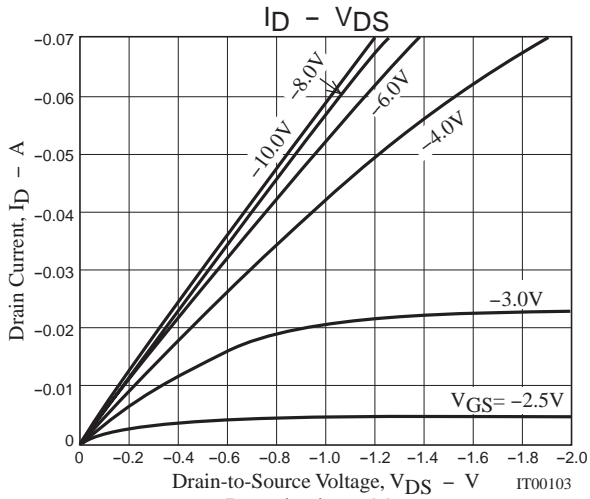

# 5HP01M

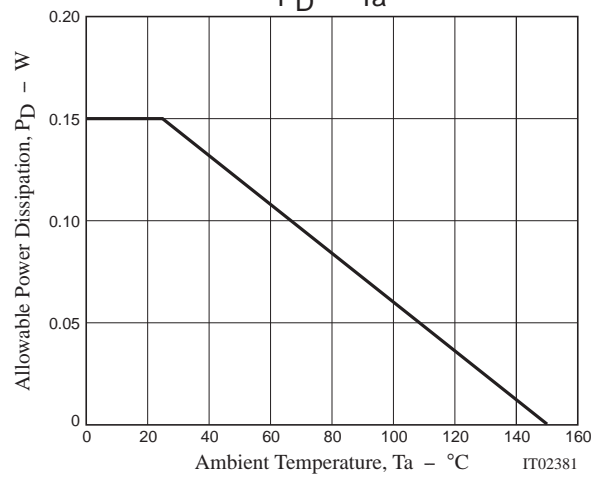
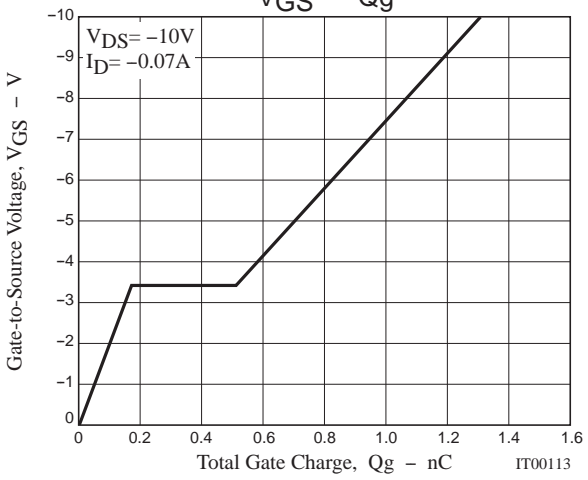
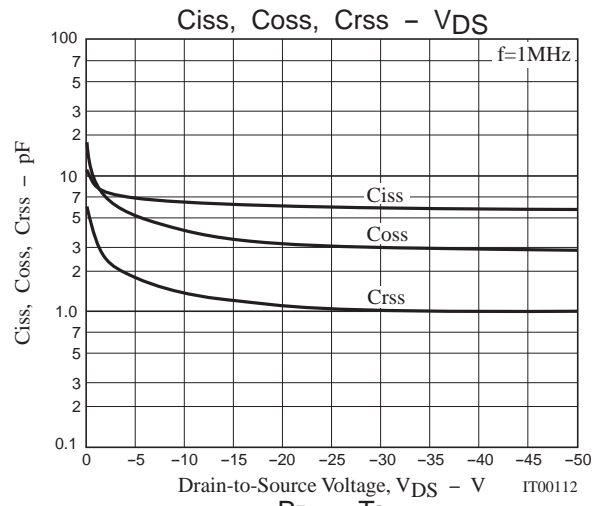
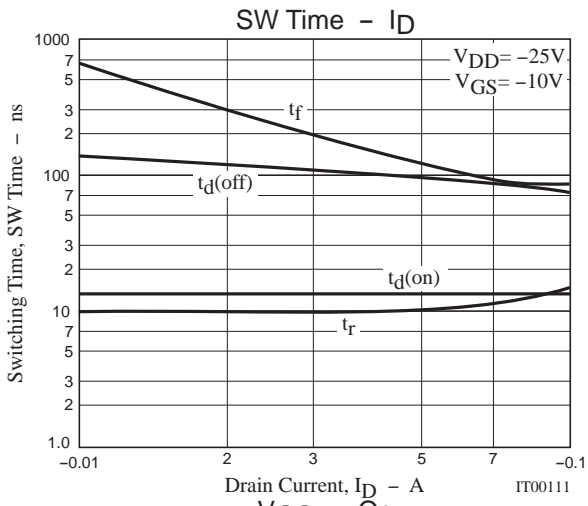



# 5HP01M

## Outline Drawing

5HP01M-TL-E, 5HP01M-TL-H

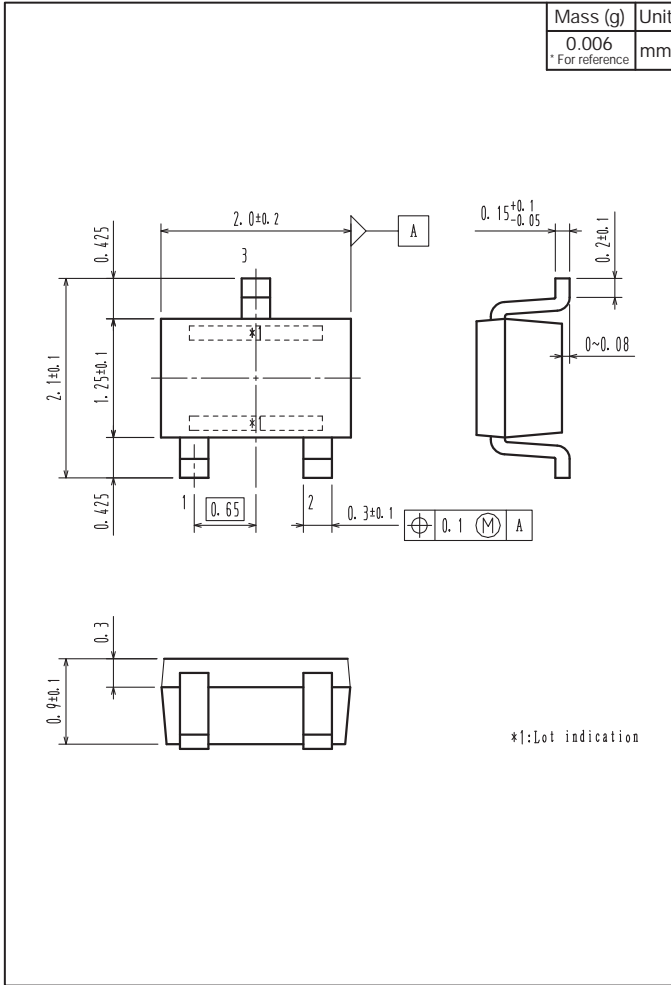

## Land Pattern Example

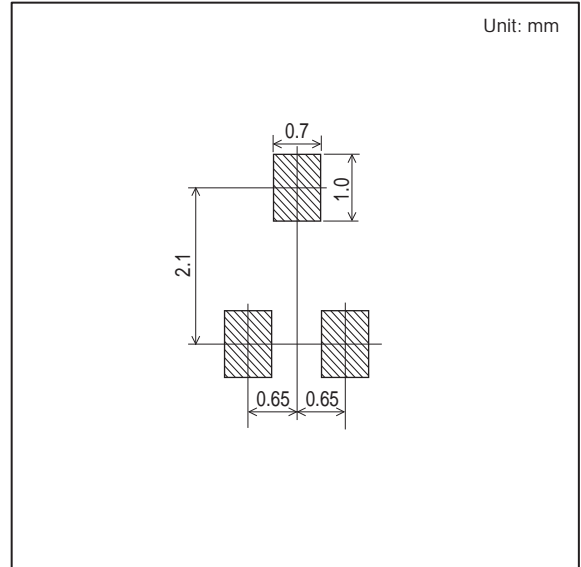

Note on usage : Since the 5HP01M is a MOSFET product, please avoid using this device in the vicinity of highly charged objects.

- Any and all SANYO Semiconductor Co.,Ltd. products described or contained herein are, with regard to "standard application", intended for the use as general electronics equipment. The products mentioned herein shall not be intended for use for any "special application" (medical equipment whose purpose is to sustain life, aerospace instrument, nuclear control device, burning appliances, transportation machine, traffic signal system, safety equipment etc.) that shall require extremely high level of reliability and can directly threaten human lives in case of failure or malfunction of the product or may cause harm to human bodies, nor shall they grant any guarantee thereof. If you should intend to use our products for new introduction or other application different from current conditions on the usage of automotive device, communication device, office equipment, industrial equipment etc. , please consult with us about usage condition (temperature, operation time etc.) prior to the intended use. If there is no consultation or inquiry before the intended use, our customer shall be solely responsible for the use.
- Specifications of any and all SANYO Semiconductor Co.,Ltd. products described or contained herein stipulate the performance, characteristics, and functions of the described products in the independent state, and are not guarantees of the performance, characteristics, and functions of the described products as mounted in the customer's products or equipment. To verify symptoms and states that cannot be evaluated in an independent device, the customer should always evaluate and test devices mounted in the customer's products or equipment.
- SANYO Semiconductor Co.,Ltd. assumes no responsibility for equipment failures that result from using products at values that exceed, even momentarily, rated values (such as maximum ratings, operating condition ranges, or other parameters) listed in products specifications of any and all SANYO Semiconductor Co.,Ltd. products described or contained herein.
- Regarding monolithic semiconductors, if you should intend to use this IC continuously under high temperature, high current, high voltage, or drastic temperature change, even if it is used within the range of absolute maximum ratings or operating conditions, there is a possibility of decrease reliability. Please contact us for a confirmation.
- SANYO Semiconductor Co.,Ltd. strives to supply high-quality high-reliability products, however, any and all semiconductor products fail or malfunction with some probability. It is possible that these probabilistic failures or malfunction could give rise to accidents or events that could endanger human lives, trouble that could give rise to smoke or fire, or accidents that could cause damage to other property. When designing equipment, adopt safety measures so that these kinds of accidents or events cannot occur. Such measures include but are not limited to protective circuits and error prevention circuits for safe design, redundant design, and structural design.
- In the event that any or all SANYO Semiconductor Co.,Ltd. products described or contained herein are controlled under any of applicable local export control laws and regulations, such products may require the export license from the authorities concerned in accordance with the above law.
- No part of this publication may be reproduced or transmitted in any form or by any means, electronic or mechanical, including photocopying and recording, or any information storage or retrieval system, or otherwise, without the prior written consent of SANYO Semiconductor Co.,Ltd.
- Any and all information described or contained herein are subject to change without notice due to product/technology improvement, etc. When designing equipment, refer to the "Delivery Specification" for the SANYO Semiconductor Co.,Ltd. product that you intend to use.
- Upon using the technical information or products described herein, neither warranty nor license shall be granted with regard to intellectual property rights or any other rights of SANYO Semiconductor Co.,Ltd. or any third party. SANYO Semiconductor Co.,Ltd. shall not be liable for any claim or suits with regard to a third party's intellectual property rights which has resulted from the use of the technical information and products mentioned above.

This catalog provides information as of July, 2012. Specifications and information herein are subject to change without notice.