

Ultrafast Diode

200 V, 20 A

FFB20UP20S

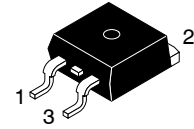

D²PAK
3-LEAD
CASE 418AJ

Description

The FFB20UP20S is an ultrafast diode with low forward voltage drop and rugged UIS capability. This device is intended for use as freewheeling and clamping diodes in a variety of switching power supplies and other power switching applications. It is specially suited for use in switching power supplies and industrial applications as welder application.

Features

- Ultrafast Recovery, $t_{rr} = 45 \text{ ns}$ (@ $I_F = 20 \text{ A}$)
- Max Forward Voltage, $V_F = 1.15 \text{ V}$ (@ $T_C = 25^\circ\text{C}$)
- Reverse Voltage, $V_{RRM} = 200 \text{ V}$
- Avalanche Energy Rated
- RoHS Compliant

Applications

- Output Rectifiers
- SMPS, Welder, UPS
- Free-Wheeling Diode for Motor Application
- Power Switching Circuits

ABSOLUTE MAXIMUM RATINGS

$T_C = 25^\circ\text{C}$ unless otherwise noted

Symbol	Parameter	Rating	Unit
V_{RRM}	Peak Repetitive Reverse Voltage	200	V
V_{RWM}	Working Peak Reverse Voltage	200	V
V_R	DC Blocking Voltage	200	V
$I_{F(AV)}$	Average Rectified Forward Current @ $T_C = 115^\circ\text{C}$	20	A
I_{FSM}	Non-repetitive Peak Surge Current 60 Hz Single Half-Sine Wave	200	A
T_J, T_{STG}	Operating Junction and Storage Temperature Range	-65 to +175	$^\circ\text{C}$

Stresses exceeding those listed in the Maximum Ratings table may damage the device. If any of these limits are exceeded, device functionality should not be assumed, damage may occur and reliability may be affected.

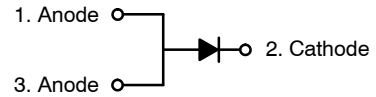

MARKING DIAGRAM

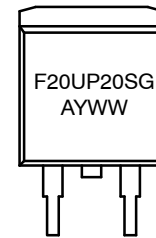

F20UP20S = Specific Device Code
A = Assembly Location
Y = Year
WW = Work Week
G = Pb-Free Package

FFB20UP20S

THERMAL CHARACTERISTICS $T_C = 25^\circ\text{C}$ unless otherwise noted

Symbol	Parameter	Max	Unit
$R_{\theta JC}$	Maximum Thermal Resistance, Junction-to-Case	2.0	$^\circ\text{C}/\text{W}$

PACKAGE MARKING AND ORDERING INFORMATION

Part Number	Top Mark	Package	Packing Method	Reel Size	Tape Width	Quantity
FFB20UP20STM	F20UP20S	D ² PAK	Reel	13" Dia	N/A	800

ELECTRICAL CHARACTERISTICS $T_C = 25^\circ\text{C}$ unless otherwise noted

Parameter	Conditions	Min	Typ	Max	Unit
V_F (Note 1)	Forward Voltage $I_F = 20\text{ A}$ $I_F = 20\text{ A}$	$T_C = 25^\circ\text{C}$ -	-	1.15 1.0	V
I_R (Note 1)	Reverse Current $V_R = 200\text{ V}$ $V_R = 200\text{ V}$	$T_C = 25^\circ\text{C}$ -	-	100 500	μA
t_{rr}	$I_F = 1\text{ A}$, $di_F/dt = 100\text{ A}/\mu\text{s}$, $V_R = 30\text{ V}$ $I_F = 20\text{ A}$, $di_F/dt = 200\text{ A}/\mu\text{s}$, $V_R = 130\text{ V}$	$T_C = 25^\circ\text{C}$	-	35 45	ns
t_a t_b Q_{rr}	$I_F = 20\text{ A}$, $di_F/dt = 200\text{ A}/\mu\text{s}$, $V_R = 130\text{ V}$	$T_C = 25^\circ\text{C}$	-	11 13 21	ns ns nC
W_{AVL}	Avalanche Energy (L = 40 mH)	20	-	-	mJ

Product parametric performance is indicated in the Electrical Characteristics for the listed test conditions, unless otherwise noted. Product performance may not be indicated by the Electrical Characteristics if operated under different conditions.

1. Pulse Test: Pulse Width = 300 μs , Duty Cycle = 2%

Test Circuit and Waveforms

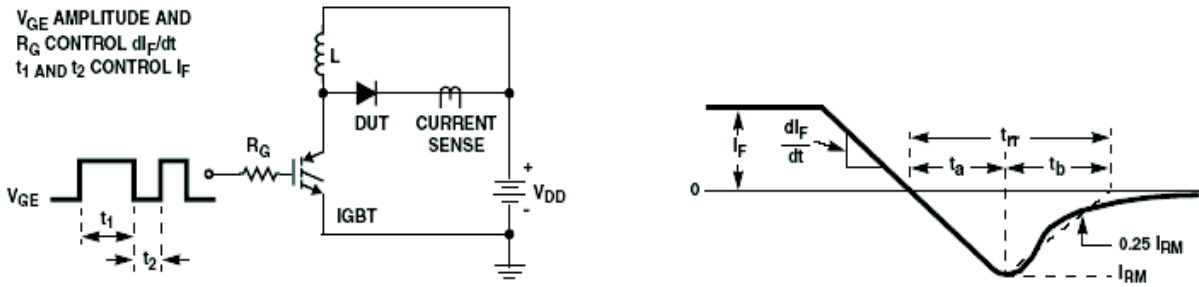

Figure 1. Diode Reverse Recovery Test Circuit & Waveform

L = 40mH
R < 0.1 Ω
V_{DD} = 50V

$E_{AVL} = 1/2LI^2 [V_{R(AVL)} / (V_{R(AVL)} - V_{DD})]$
Q1 = IGBT (BV_{CES} > DUT V_{R(AVL)})

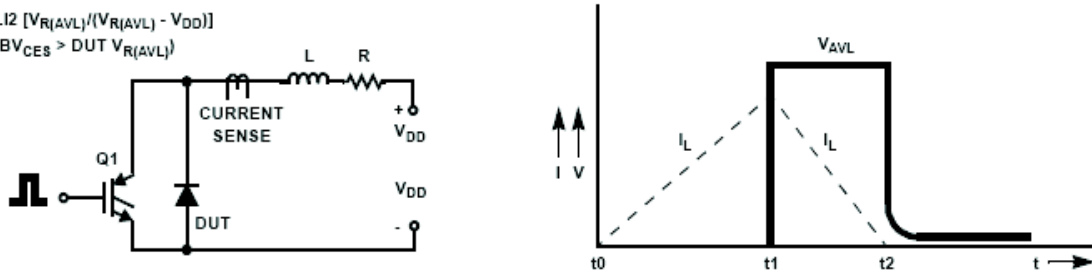

Figure 2. Unclamped Inductive Switching Test Circuit & Waveform

FFB20UP20S

TYPICAL CHARACTERISTICS

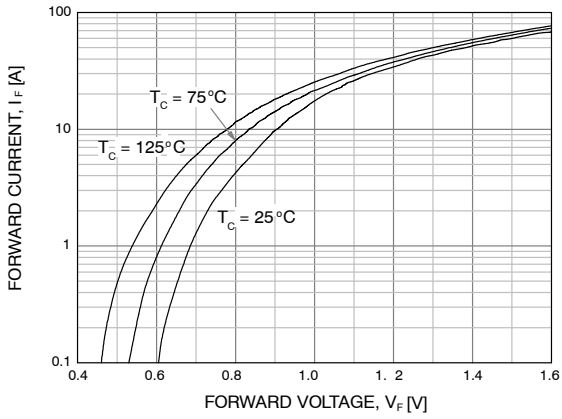

Figure 3. Typical Forward Voltage Drop

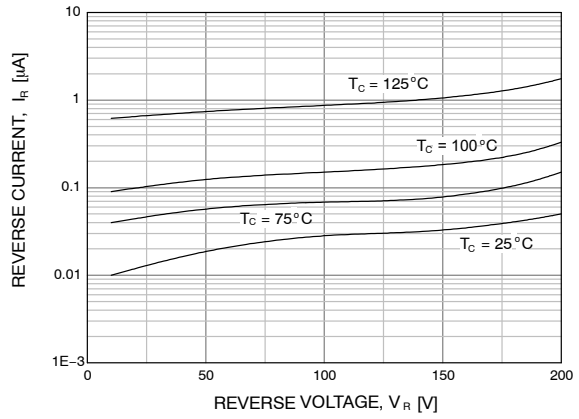

Figure 4. Typical Reverse Current

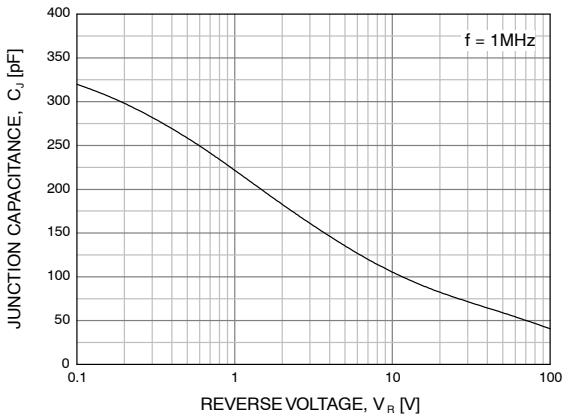

Figure 5. Typical Junction Capacitance

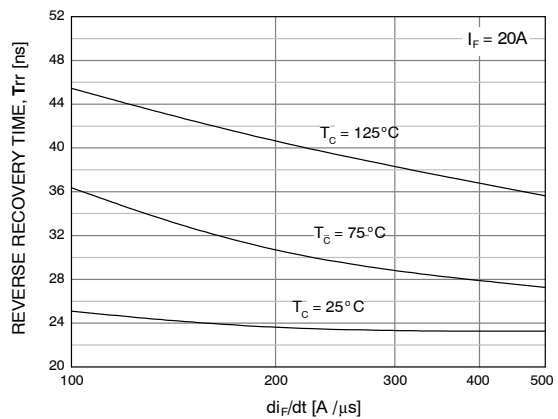

Figure 6. Typical Reverse Recovery Time

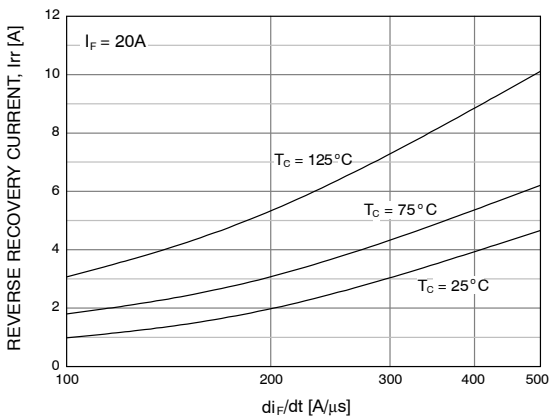

Figure 7. Typical Reverse Recovery Current

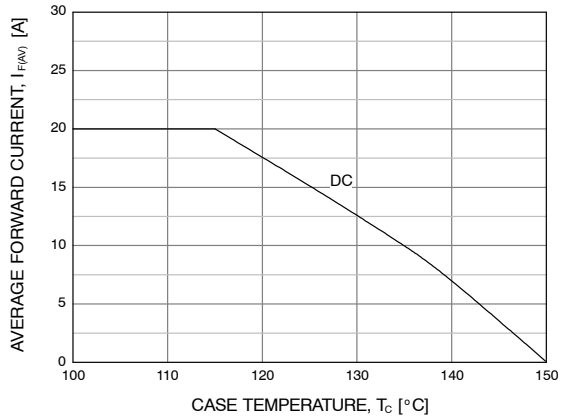
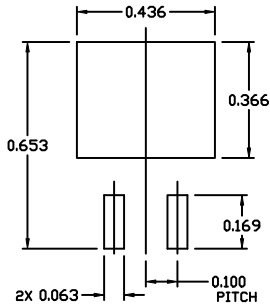

Figure 8. Forward Current Derating Curve

FFB20UP20S

PACKAGE DIMENSIONS

D²PAK-3 (TO-263, 3-LEAD) CASE 418AJ ISSUE F



RECOMMENDED
MOUNTING FOOTPRINT

For additional information on our Pb-free strategy and soldering details, please download the IM Semiconductor Soldering and Mounting Techniques Reference Manual, SOLDER/D.

NOTES:

1. DIMENSIONING AND TOLERANCING PER ASME Y14.5M, 2009.
2. CONTROLLING DIMENSION: INCHES
3. CHAMFER OPTIONAL.
4. DIMENSIONS D AND E DO NOT INCLUDE MOLD FLASH. MOLD FLASH SHALL NOT EXCEED 0.005 PER SIDE. THESE DIMENSIONS ARE MEASURED AT THE OUTERMOST EXTREMES OF THE PLASTIC BODY AT DATUM H.
5. THERMAL PAD CONTOUR IS OPTIONAL WITHIN DIMENSIONS E, L1, D1, AND E1.
6. OPTIONAL MOLD FEATURE.
7. Ⓛ, Ⓞ ... OPTIONAL CONSTRUCTION FEATURE CALL OUTS.

DIM	INCHES		MILLIMETERS	
	MIN.	MAX.	MIN.	MAX.
A	0.160	0.190	4.06	4.83
A1	0.000	0.010	0.00	0.25
b	0.020	0.039	0.51	0.99
c	0.012	0.029	0.30	0.74
c2	0.045	0.065	1.14	1.65
D	0.330	0.380	8.38	9.65
D1	0.260	---	6.60	---
E	0.380	0.420	9.65	10.67
E1	0.245	---	6.22	---
e	0.100	BSC	2.54	BSC
H	0.575	0.625	14.60	15.88
L	0.070	0.110	1.78	2.79
L1	---	0.066	---	1.68
L2	---	0.070	---	1.78
L3	0.010	BSC	0.25	BSC
M	0°	8°	0°	8°

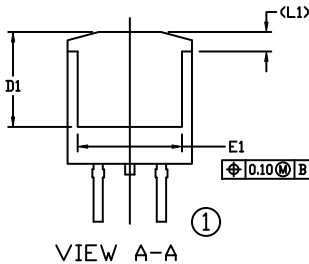
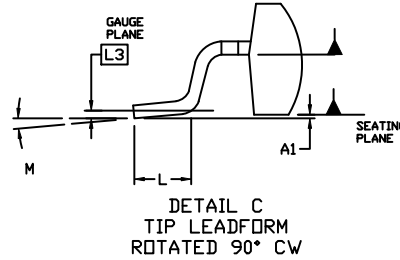
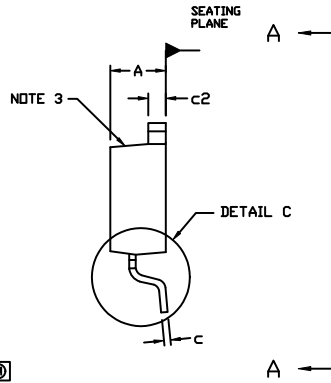
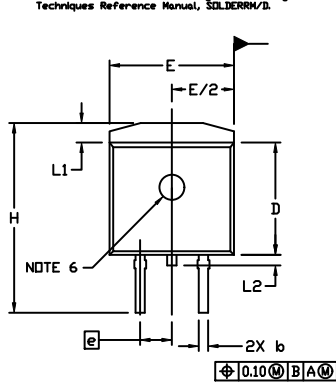

VIEW A-A

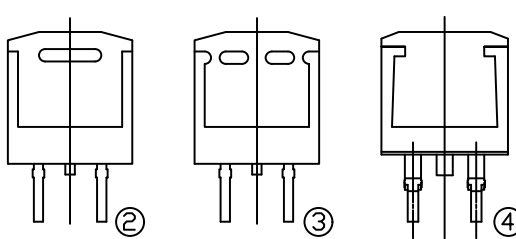

VIEW A-A
OPTIONAL CONSTRUCTIONS

onsemi, Onsemi, and other names, marks, and brands are registered and/or common law trademarks of Semiconductor Components Industries, LLC dba "onsemi" or its affiliates and/or subsidiaries in the United States and/or other countries. onsemi owns the rights to a number of patents, trademarks, copyrights, trade secrets, and other intellectual property. A listing of onsemi's product/patent coverage may be accessed at www.onsemi.com/site/pdf/Patent-Marking.pdf. onsemi reserves the right to make changes at any time to any products or information herein, without notice. The information herein is provided "as-is" and onsemi makes no warranty, representation or guarantee regarding the accuracy of the information, product features, availability, functionality, or suitability of its products for any particular purpose, nor does onsemi assume any liability arising out of the application or use of any product or circuit, and specifically disclaims any and all liability, including without limitation special, consequential or incidental damages. Buyer is responsible for its products and applications using onsemi products, including compliance with all laws, regulations and safety requirements or standards, regardless of any support or applications information provided by onsemi. "Typical" parameters which may be provided in onsemi data sheets and/or specifications can and do vary in different applications and actual performance may vary over time. All operating parameters, including "Typicals" must be validated for each customer application by customer's technical experts. onsemi does not convey any license under any of its intellectual property rights nor the rights of others. onsemi products are not designed, intended, or authorized for use as a critical component in life support systems or any FDA Class 3 medical devices or medical devices with a same or similar classification in a foreign jurisdiction or any devices intended for implantation in the human body. Should Buyer purchase or use onsemi products for any such unintended or unauthorized application, Buyer shall indemnify and hold onsemi and its officers, employees, subsidiaries, affiliates, and distributors harmless against all claims, costs, damages, and expenses, and reasonable attorney fees arising out of, directly or indirectly, any claim of personal injury or death associated with such unintended or unauthorized use, even if such claim alleges that onsemi was negligent regarding the design or manufacture of the part. onsemi is an Equal Opportunity/Affirmative Action Employer. This literature is subject to all applicable copyright laws and is not for resale in any manner.

PUBLICATION ORDERING INFORMATION

LITERATURE FULFILLMENT:
Email Requests to: orderlit@onsemi.com

onsemi Website: www.onsemi.com

TECHNICAL SUPPORT
North American Technical Support:
Voice Mail: 1 800-282-9855 Toll Free USA/Canada
Phone: 011 421 33 790 2910

Europe, Middle East and Africa Technical Support:
Phone: 00421 33 790 2910
For additional information, please contact your local Sales Representative