

# FP1007

## High frequency, high current power inductors



### Product description

- High current carrying capacity
- Low core loss
- Frequency range up to 2MHz
- Inductance Range from 115 nH to 300nH
- Current range from 32 to 94 amps
- 10.4 x 8.0mm footprint surface mount package in 6.5, 7.0 or 7.5mm height
- Ferrite core material
- Halogen free, lead free, RoHS compliant

### Applications

- Servers
- Multi-phase and Vcore regulators
- Voltage Regulator Modules (VRMs)
- Desktop VRMs and EVRDs
- Data networking and storage systems
- Graphics cards and battery power systems
- Point-of-Load modules
- DCR Sensing circuits

### Environmental data

- Storage temperature range (Component): -40°C to +125°C
- Operating temperature range: -40°C to +125°C (ambient + self-temperature rise)
- Solder reflow temperature: J-STD-020D compliant



Product specifications

Part Number <sup>7</sup>	OCL <sup>1</sup> (nH)±10%	FLL <sup>2</sup> (nH) minimum	I <sub>rms</sub> <sup>3</sup> (amps)	I <sub>sat,1</sub> <sup>4</sup> (amps)	I <sub>sat,2</sub> <sup>5</sup> (amps)	DCR (mΩ) @ 20°C ±5%	K-factor <sup>8</sup>
<b>R1 version</b>							
FP1007R1-R12-R	120	86	60	81	65	0.29 ± 10%	371
FP1007R1-R14-R	140	100	60	72	56	0.29 ± 10%	371
FP1007R1-R17-R	170	122	60	58	46	0.29 ± 10%	371
FP1007R1-R22-R	215	155	60	50	36	0.29 ± 10%	371
FP1007R1-R30-R	300	216	60	32	26	0.29 ± 10%	371
<b>R2 version</b>							
FP1007R2-R12-R	120	86	51	81	65	0.48 ± 8%	368
FP1007R2-R14-R	140	100	51	72	56	0.48 ± 8%	368
FP1007R2-R17-R	170	122	51	58	46	0.48 ± 8%	368
FP1007R2-R22-R	215	155	51	50	36	0.48 ± 8%	368
FP1007R2-R30-R	300	216	51	32	26	0.48 ± 8%	368
<b>R3 version</b>							
FP1007R3-R12-R	115	83	61	94	86	0.29 ± 5%	354
FP1007R3-R15-R	150	108	61	76	70	0.29 ± 5%	354
FP1007R3-R17-R	175	126	61	66	60	0.29 ± 5%	354
FP1007R3-R22-R	215	155	61	50	43	0.29 ± 5%	354
FP1007R3-R23-R	230	165	61	48	40	0.29 ± 5%	354
FP1007R3-R27-R	270	194	61	40	34	0.29 ± 5%	354
FP1007R3-R30-R	300	216	61	35	30	0.29 ± 5%	354

- Open Circuit Inductance (OCL) Test Parameters: 100kHz, 0.1Vrms, 0.0Aac, +25°C
- Full Load Inductance (FLL) Test Parameters: 100kHz, 0.1Vrms, I<sub>sat,1</sub>, +25°C
- I<sub>rms</sub>: Irms: DC current for an approximate temperature rise of 40°C without core loss. Derating is necessary for AC currents. PCB layout, trace thickness and width, air-flow, and proximity of other heat generating components will affect the temperature rise. It is recommended that the temperature of the part not exceed 125°C under worst case operating conditions verified in the end application.
- I<sub>sat,1</sub>: Peak current for approximately 20% rolloff @ +25°C
- I<sub>sat,2</sub>: Peak current for approximately 20% rolloff @ +125°C

- K-factor: Used to determine B<sub>pp</sub> for core loss (see graph).  
B<sub>pp</sub> = K \* L \* ΔI \* 10<sup>-3</sup>. B<sub>pp</sub> (Gauss), K: (K-factor from table),  
L: (Inductance in nH), ΔI (Peak-to-peak ripple current in Amps).
- Part Number Definition: FP1007Rx-Rxx-R  
FP1007R= Product code and size  
x = DCR indicator  
Rxx = Inductance value in μH, R= decimal point  
-R suffix = RoHS compliant

Dimensions (mm)

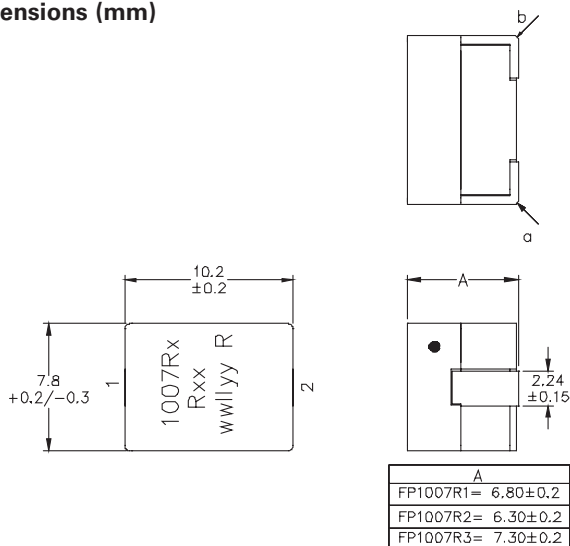

Recommended Pad Layout

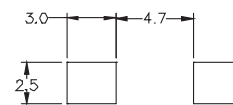

Schematic

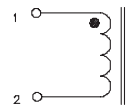

Part marking: 1007Rx (x = DCR indicator), Rxx (xx = inductance value in μH, R = decimal point, wwlllyy = date code, R = revision level)  
Tolerances are ±0.25 millimeters unless stated otherwise.  
PCB tolerances are ±0.1 millimeters unless stated otherwise  
All soldering surfaces to be coplanar within 0.1 millimeter  
DCR measured from point "a" to point "b"  
Do not route traces or vias underneath the inductor

**Packaging information (mm)**

Supplied in tape and reel packaging,  
 FP1007R1 700 parts per 13 " diameter reel  
 FP1007R2 750 parts per 13 " diameter reel  
 FP1007R3 650 parts per 13 " diameter reel

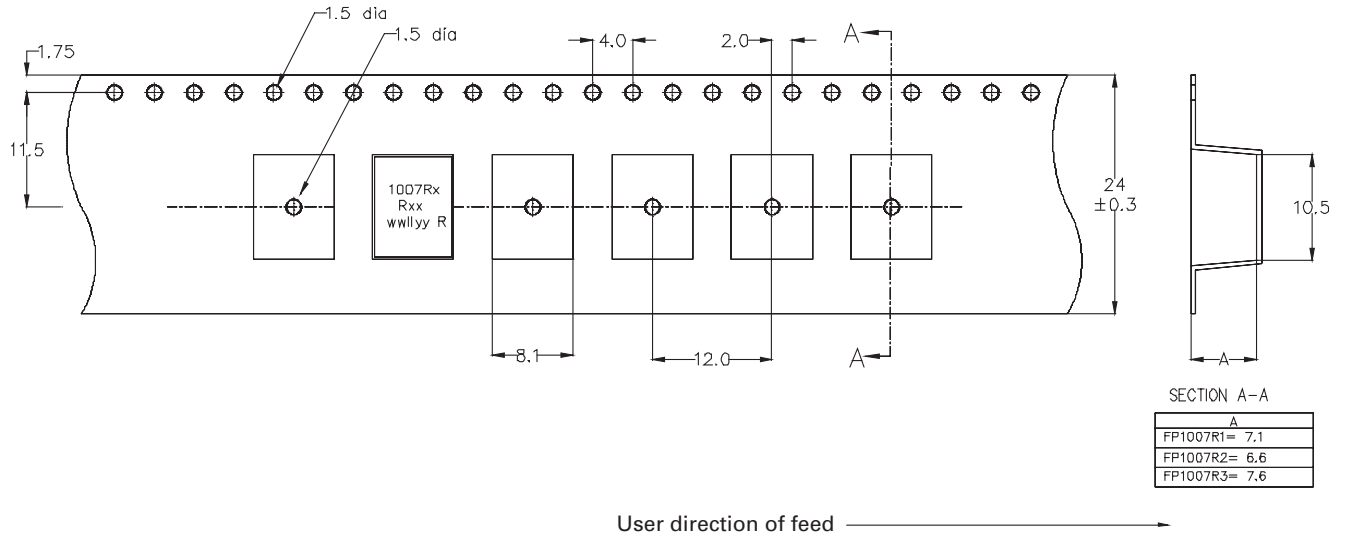

**Temperature rise vs. total loss**

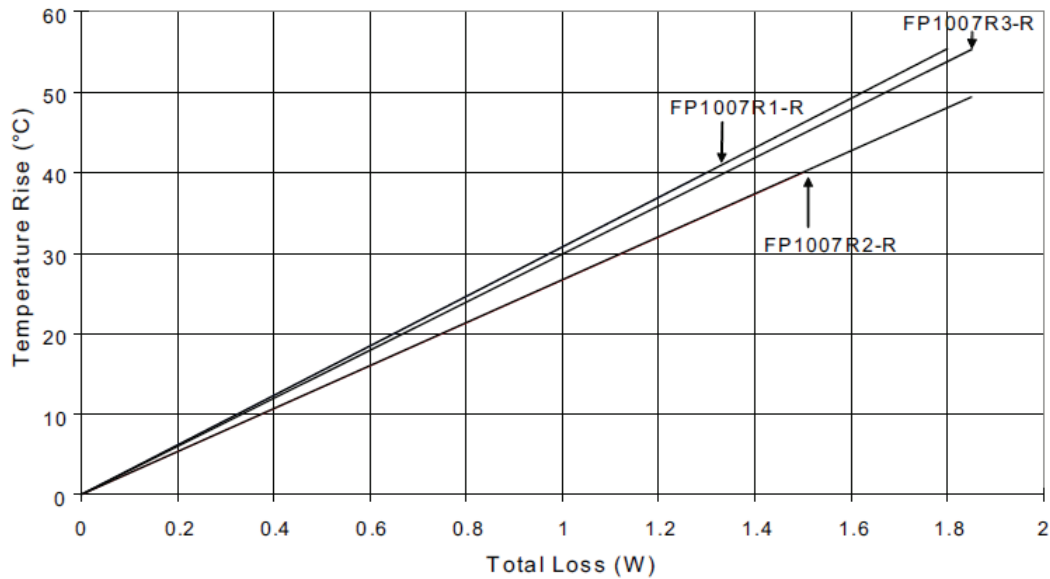

Core loss vs.  $B_{p-p}$

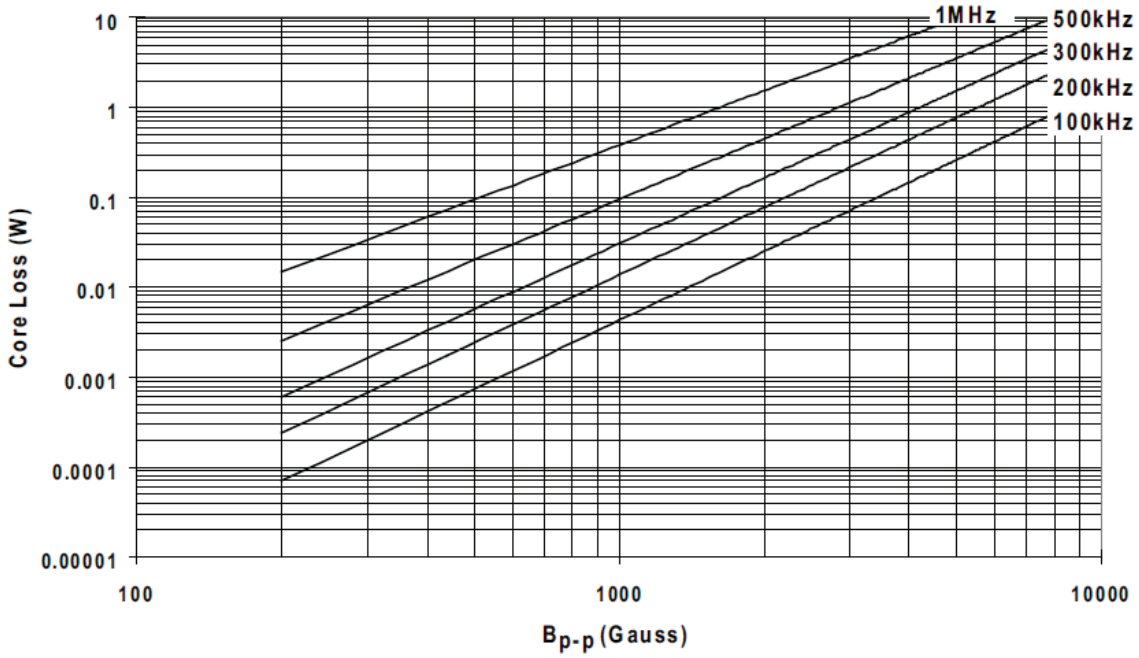

Inductance characteristics

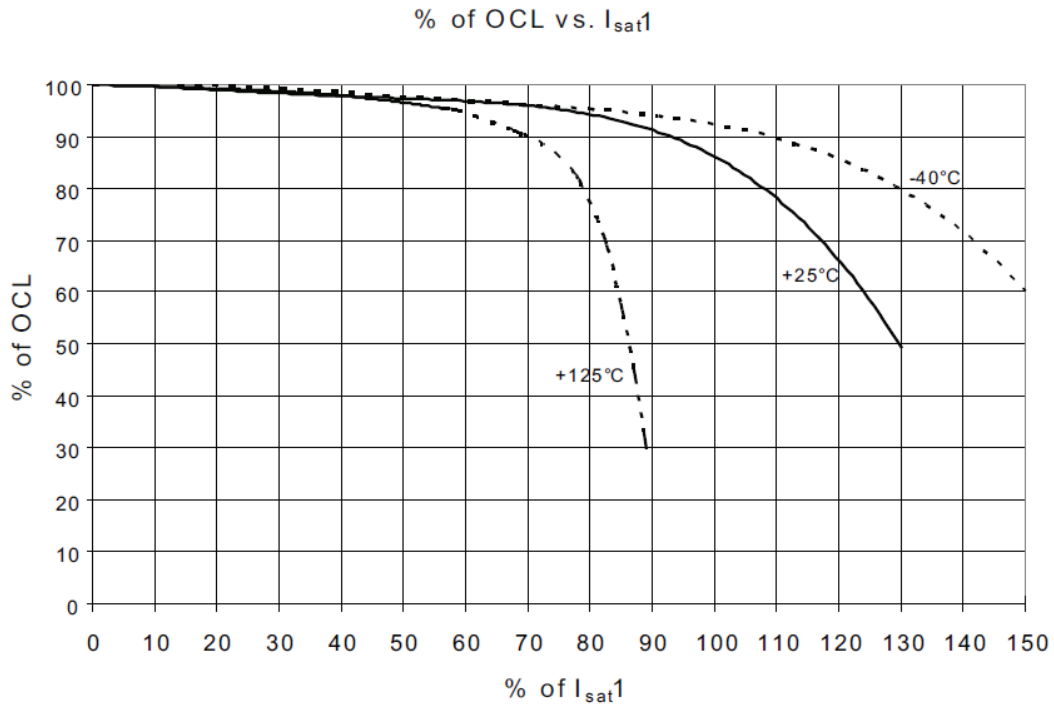

**Solder reflow profile**



**Table 1 - Standard SnPb Solder ( $T_C$ )**

Package Thickness	Volume $\text{mm}^3$ <350	Volume $\text{mm}^3$ $\geq$ 350
<2.5mm)	235°C	220°C
$\geq$ 2.5mm	220°C	220°C

**Table 2 - Lead (Pb) Free Solder ( $T_C$ )**

Package Thickness	Volume $\text{mm}^3$ <350	Volume $\text{mm}^3$ 350 - 2000	Volume $\text{mm}^3$ >2000
<1.6mm	260°C	260°C	260°C
1.6 – 2.5mm	260°C	250°C	245°C
>2.5mm	250°C	245°C	245°C

**Reference JDEC J-STD-020D**

Profile Feature	Standard SnPb Solder	Lead (Pb) Free Solder
Preheat and Soak		
• Temperature min. ( $T_{smin}$ )	100°C	150°C
• Temperature max. ( $T_{smax}$ )	150°C	200°C
• Time ( $T_{smin}$ to $T_{smax}$ ) ( $t_s$ )	60-120 Seconds	60-120 Seconds
Average ramp up rate $T_{smax}$ to $T_p$	3°C/ Second Max.	3°C/ Second Max.
Liquidous temperature ( $T_L$ )	183°C	217°C
Time at liquidous ( $t_L$ )	60-150 Seconds	60-150 Seconds
Peak package body temperature ( $T_p$ )*	Table 1	Table 2
Time ( $t_p$ )** within 5 °C of the specified classification temperature ( $T_C$ )	20 Seconds**	30 Seconds**
Average ramp-down rate ( $T_p$ to $T_{smax}$ )	6°C/ Second Max.	6°C/ Second Max.
Time 25°C to Peak Temperature	6 Minutes Max.	8 Minutes Max.

\* Tolerance for peak profile temperature ( $T_p$ ) is defined as a supplier minimum and a user maximum.  
 \*\* Tolerance for time at peak profile temperature ( $t_p$ ) is defined as a supplier minimum and a user maximum.

Life Support Policy: Eaton does not authorize the use of any of its products for use in life support devices or systems without the express written approval of an officer of the Company. Life support systems are devices which support or sustain life, and whose failure to perform, when properly used in accordance with instructions for use provided in the labeling, can be reasonably expected to result in significant injury to the user.

**Eaton**  
**Electronics Division**  
 1000 Eaton Boulevard  
 Cleveland, OH 44122  
 United States  
 www.eaton.com/elx

© 2015 Eaton  
 All Rights Reserved  
 Printed in USA  
 Publication No. 4341 BU-10927  
 October 2015



Eaton is a registered trademark.  
 All other trademarks are property of their respective owners.