

## 300mW, NPN Small Signal Transistor

### FEATURES

- Low power loss, high efficiency
- Ideal for automated placement
- High surge current capability
- Moisture sensitivity level: level 1, per J-STD-020
- RoHS Compliant
- Halogen-free according to IEC 61249-2-21

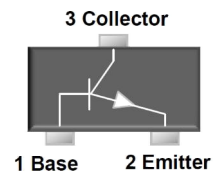
### APPLICATIONS

- Switching mode power supply (SMPS)
- Adapters
- Lighting application
- On-board DC/DC converter

### MECHANICAL DATA

- Case: SOT-23
- Molding compound: UL flammability classification rating 94V-0
- Matte tin plated leads, solderable per J-STD-002
- Meet JESD 201 class 1A whisker test
- Polarity: Indicated by cathode band
- Weight: 8 mg (approximately)

KEY PARAMETERS		
PARAMETER	VALUE	UNIT
$V_{CBO}$	75	V
$V_{CEO}$	40	V
$V_{EBO}$	6	V
$I_C$	600	mA
$h_{FE}$	300	
Package	SOT-23	
Configuration	Single die	



ABSOLUTE MAXIMUM RATINGS ( $T_A = 25^\circ\text{C}$ unless otherwise noted)			
PARAMETER	SYMBOL	MMBT2222A	UNIT
Marking code on the device		1P	
Collector-base voltage, emitter open	$V_{CBO}$	75	V
Collector-emitter voltage, base open	$V_{CEO}$	40	V
Emitter-base voltage, collector open	$V_{EBO}$	6	V
Collector current, dc	$I_C$	600	mA
Total dc power input to all terminals	$P_T$	300	mW
Junction temperature	$T_J$	-55 to +150	$^\circ\text{C}$
Storage temperature	$T_{STG}$	-55 to +150	$^\circ\text{C}$

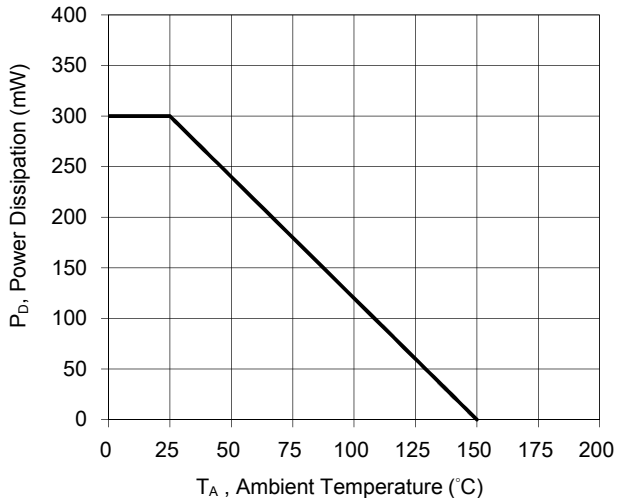
<b>ELECTRICAL SPECIFICATIONS</b> ( $T_A = 25^\circ\text{C}$ unless otherwise noted)						
PARAMETER	CONDITIONS	SYMBOL	MIN	TYP	MAX	UNIT
Collector-base breakdown voltage, emitter open	$I_C = 10\ \mu\text{A}, I_E = 0$	$V_{(BR)CBO}$	75	-	-	V
Collector-emitter breakdown voltage, base open	$I_C = 10\ \text{mA}, I_B = 0$	$V_{(BR)CEO}$	40	-	-	V
Emitter-base breakdown voltage, collector open	$I_E = 10\ \mu\text{A}, I_C = 0$	$V_{(BR)EBO}$	6	-	-	V
Collector cutoff current, emitter open	$V_{CB} = 60\ \text{V}, I_E = 0$	$I_{CBO}$	-	-	0.01	$\mu\text{A}$
Emitter cutoff current, collector open	$V_{EB} = 3\ \text{V}, I_C = 0$	$I_{EBO}$	-	-	0.1	$\mu\text{A}$
DC Current Gain	$V_{CE} = 10\ \text{V}, I_C = 500\ \text{mA}$	$h_{FE}$	40	-	-	
	$V_{CE} = 10\ \text{V}, I_C = 150\ \text{mA}$		100	-	300	
	$V_{CE} = 10\ \text{V}, I_C = 10\ \text{mA}$		75	-	-	
	$V_{CE} = 10\ \text{V}, I_C = 1\ \text{mA}$		50	-	-	
	$V_{CE} = 10\ \text{V}, I_C = 0.1\ \text{mA}$		35	-	-	
Collector-emitter saturation voltage	$I_C = 500\ \text{mA}, I_B = 50\ \text{mA}$	$V_{CE(sat)}$	-	-	1	V
Base-emitter saturation voltage	$I_C = 500\ \text{mA}, I_B = 50\ \text{mA}$	$V_{BE(sat)}$	-	-	2	V
Transition frequency	$V_{CE} = 20\ \text{V}, I_C = 20\ \text{mA}, f = 100\ \text{MHz}$	$f_T$	300	-	-	MHz
Output Capacitance	1 MHz, $V_{CB} = 10\ \text{V}, I_E = 0$	$C_{OBO}$	8			pF
Input Capacitance	1 MHz, $V_{EB} = 0.5\ \text{V}, I_C = 0$	$C_{IBO}$	25			pF
Delay Time	$V_{CC} = 30\ \text{V}, V_{BE(off)} = -0.5\ \text{V}, I_C = 150\ \text{mA}$	$t_d$	-	-	10	ns
Rise Time	$I_{B1} = 15\ \text{mA}$	$t_r$	-	-	25	ns
Storage Time	$V_{CC} = 30\ \text{V}, I_{B1} = -I_{B2} = 15\ \text{mA}, I_C = 150\ \text{mA}$	$t_s$	-	-	225	ns
Fall Time	$V_{CC} = 30\ \text{V}, I_{B1} = -I_{B2} = 15\ \text{mA}, I_C = 150\ \text{mA}$	$t_f$	-	-	60	ns

<b>ORDERING INFORMATION</b>		
ORDERING CODE	PACKAGE	PACKING
MMBT2222A RFG	SOT-23	3K / 7" Reel

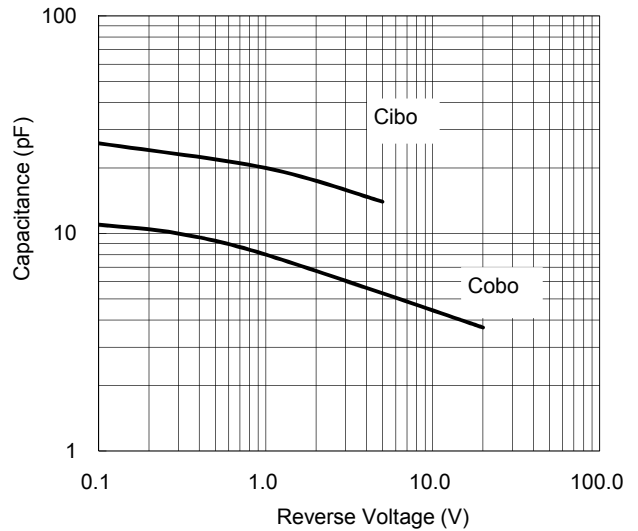
**CHARACTERISTICS CURVES**

( $T_A = 25^\circ\text{C}$  unless otherwise noted)

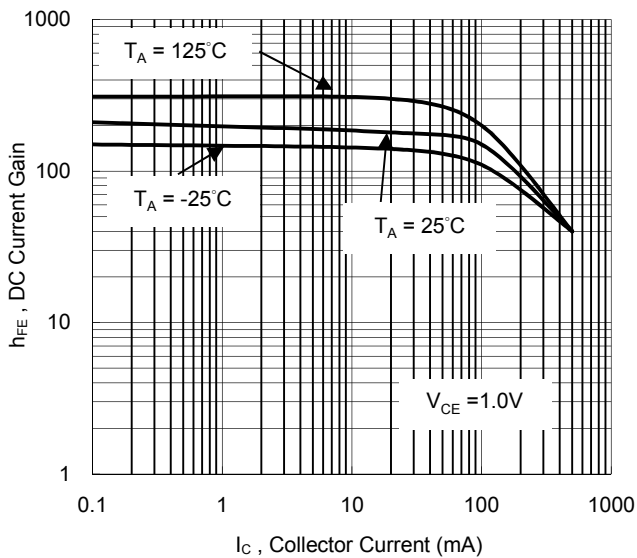
**Fig. 1 Max Power Dissipation VS. Ambient Temperature**



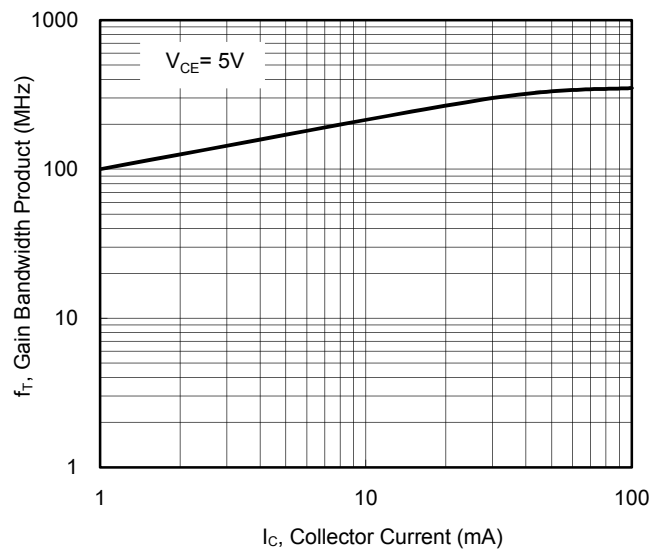
**Fig.2 Typical Capacitance**



**Fig.3 Typical DC Current Gain VS. Collector Current**



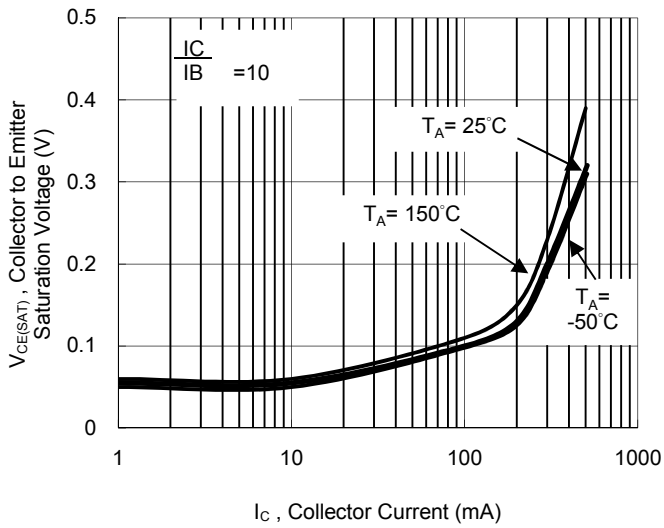
**Fig.4 Gain Bandwidth Product VS. Collector Current**



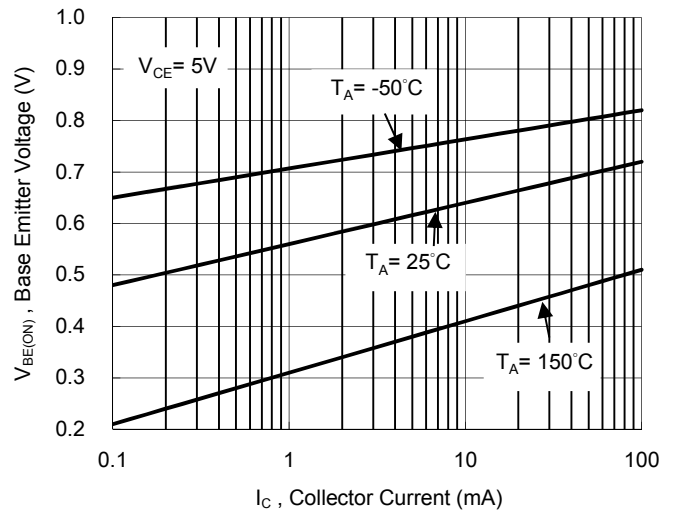
**CHARACTERISTICS CURVES**

( $T_A = 25^\circ\text{C}$  unless otherwise noted)

**Fig.5 Collector Emitter Saturation Voltage VS. Collector Current**

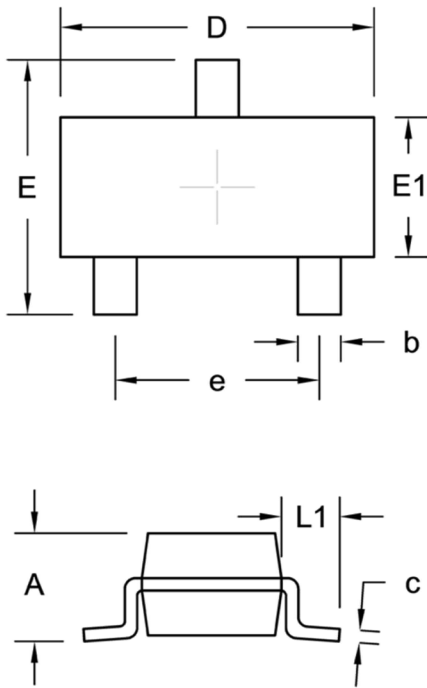


**Fig.6 Base Emitter Voltage vs. Collector Current**



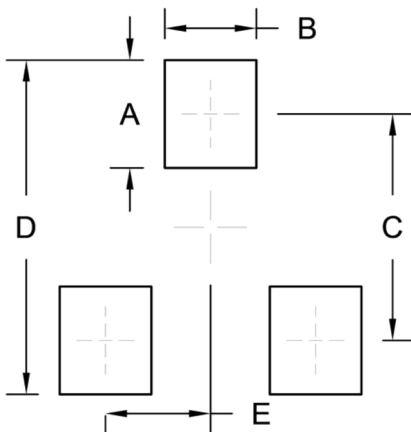
**PACKAGE OUTLINE DIMENSION**

**SOT-23**



DIM.	Unit (mm)		Unit (inch)	
	Min.	Max.	Min.	Max.
A	0.89	1.12	0.035	0.044
b	0.30	0.50	0.012	0.020
c	0.08	0.20	0.003	0.008
D	2.80	3.04	0.110	0.120
E	2.10	2.64	0.083	0.104
E1	1.20	1.40	0.047	0.055
e	1.90 BSC		0.075 BSC	
L1	0.54 REF.		0.021 REF.	

**SUGGESTED PAD LAYOUT**



Symbol	Unit (mm)	Unit (inch)
A	1.00	0.039
B	0.85	0.033
C	2.10	0.083
D	3.10	0.122
E	0.98	0.039

## Notice

Specifications of the products displayed herein are subject to change without notice. TSC or anyone on its behalf, assumes no responsibility or liability for any errors or inaccuracies.

Purchasers are solely responsible for the choice, selection, and use of TSC products and TSC assumes no liability for application assistance or the design of Purchasers' products.

Information contained herein is intended to provide a product description only. No license, express or implied, to any intellectual property rights is granted by this document. Except as provided in TSC's terms and conditions of sale for such products, TSC assumes no liability whatsoever, and disclaims any express or implied warranty, relating to sale and/or use of TSC products including liability or warranties relating to fitness for a particular purpose, merchantability, or infringement of any patent, copyright, or other intellectual property right.

The products shown herein are not designed for use in medical, life-saving, or life-sustaining applications. Customers using or selling these products for use in such applications do so at their own risk and agree to fully indemnify TSC for any damages resulting from such improper use or sale.