

ZENER DIODE

FEATURES

- Planar Die Construction
- Ultra-Small Surface Mount Package
- General purpose, Medium Current
- Ideally Suited for Automated Assembly Processes
- P/N suffix V means AEC-Q101 qualified, e.g:MMSZ5221BSV
- P/N suffix V means Halogen-free

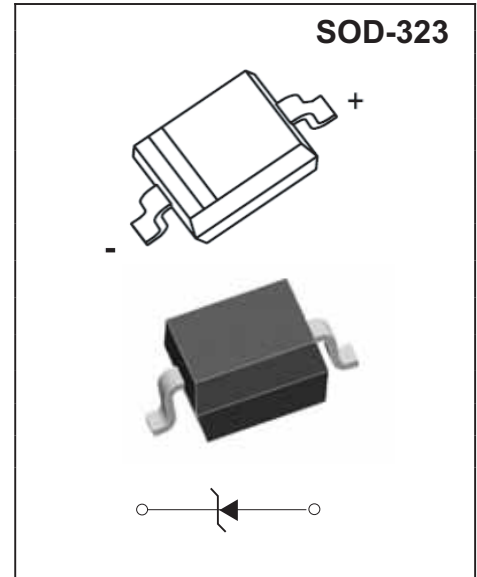

Maximum Ratings($T_a=25^\circ\text{C}$ unless otherwise specified)

Characteristic	Symbol	Value	Unit
Forward Voltage (Note 2) @ $I_F = 10\text{mA}$	V_F	0.9	V
Power Dissipation(Note 1)	P_D	500	mW
Thermal Resistance, Junction to Ambient Air	$R_{\theta JA}$	625	$^\circ\text{C/W}$
Junction Temperature	T_j	-30~+150	$^\circ\text{C}$
Storage Temperature Range	T_{stg}	-55~+150	$^\circ\text{C}$

Notes:1. Device mounted on ceramic PCBS; 7.6 mm x 9.4 mm x 0.87 mm with pad areas 25 mm².
2. Tested with pulses, $T_p \leq 1.0\text{ms}$.

ELECTRICAL CHARACTERISTICS $T_a=25^{\circ}\text{C}$ unless otherwise specified

Type Number	Code	Zener Voltage Range (Note 2)				Maximum Zener Impedance (Note 4)			Maximum Reverse Current	
		$V_Z@I_{ZT}$			I_{ZT}	$Z_{ZT}@I_{ZT}$	$Z_{ZK}@I_{ZK}$	I_{ZK}	I_R	V_R
		Nom(V)	Min(V)	Max(V)	mA	Ω		mA	μA	V
MMSZ5221BS	C1	2.4	2.28	2.52	20	30	1200	0.25	100	1.0
MMSZ5223BS	C3	2.7	2.57	2.84	20	30	1300	0.25	75	1.0
MMSZ5225BS	C5	3.0	2.85	3.15	20	30	1600	0.25	50	1.0
MMSZ5226BS	G1	3.3	3.14	3.47	20	28	1600	0.25	25	1.0
MMSZ5227BS	G2	3.6	3.42	3.78	20	24	1700	0.25	15	1.0
MMSZ5228BS	G3	3.9	3.71	4.10	20	23	1900	0.25	10	1.0
MMSZ5229BS	G4	4.3	4.09	4.52	20	22	2000	0.25	5	1.0
MMSZ5230BS	G5	4.7	4.47	4.94	20	19	1900	0.25	5	2.0
MMSZ5231BS	E1	5.1	4.85	5.36	20	17	1600	0.25	5	2.0
MMSZ5232BS	E2	5.6	5.32	5.88	20	11	1600	0.25	5	3.0
MMSZ5233BS	E3	6.0	5.70	6.30	20	7	1600	0.25	5	3.5
MMSZ5234BS	E4	6.2	5.89	6.51	20	7	1000	0.25	5	4.0
MMSZ5235BS	E5	6.8	6.46	7.14	20	5	750	0.25	3	5.0
MMSZ5236BS	F1	7.5	7.13	7.88	20	6	500	0.25	3	6.0
MMSZ5237BS	F2	8.2	7.79	8.61	20	8	500	0.25	3	6.5
MMSZ5238BS	F3	8.7	8.27	9.14	20	8	600	0.25	3	6.5
MMSZ5239BS	F4	9.1	8.65	9.56	20	10	600	0.25	3	7.0
MMSZ5240BS	F5	10	9.50	10.50	20	17	600	0.25	3	8.0
MMSZ5241BS	H1	11	10.45	11.55	20	22	600	0.25	2.0	8.4
MMSZ5242BS	H2	12	11.40	12.60	20	30	600	0.25	1.0	9.1
MMSZ5243BS	H3	13	12.35	13.65	9.5	13	600	0.25	0.5	9.9
MMSZ5244BS	H4	14	13.30	14.70	9.0	15	600	0.25	0.1	10
MMSZ5245BS	H5	15	14.25	15.75	8.5	16	600	0.25	0.1	11
MMSZ5246BS	J1	16	15.20	16.80	7.8	17	600	0.25	0.1	12
MMSZ5248BS	J3	18	17.10	18.90	7.0	21	600	0.25	0.05	14
MMSZ5250BS	J5	20	19.00	21.00	6.2	25	600	0.25	0.05	15
MMSZ5251BS	K1	22	20.90	23.10	5.6	29	600	0.25	0.05	17
MMSZ5252BS	K2	24	22.80	25.20	5.2	33	600	0.25	0.05	18
MMSZ5253BS	K3	25	23.75	26.25	5.0	35	600	0.25	0.05	19
MMSZ5254BS	K4	27	25.65	28.35	5.0	41	600	0.25	0.05	21
MMSZ5255BS	K5	28	26.60	29.40	4.5	44	600	0.25	0.05	21
MMSZ5256BS	M1	30	28.50	31.50	4.2	49	600	0.25	0.05	23
MMSZ5257BS	M2	33	31.35	34.65	3.8	58	700	0.25	0.05	25
MMSZ5258BS	M3	36	34.20	37.80	3.4	70	700	0.25	0.05	27
MMSZ5259BS	M4	39	37.05	40.95	3.2	80	800	0.25	0.05	30

RATING AND CHARACTERISTICS CURVES (MMSZ5221BS THRU MMSZ5259BS)

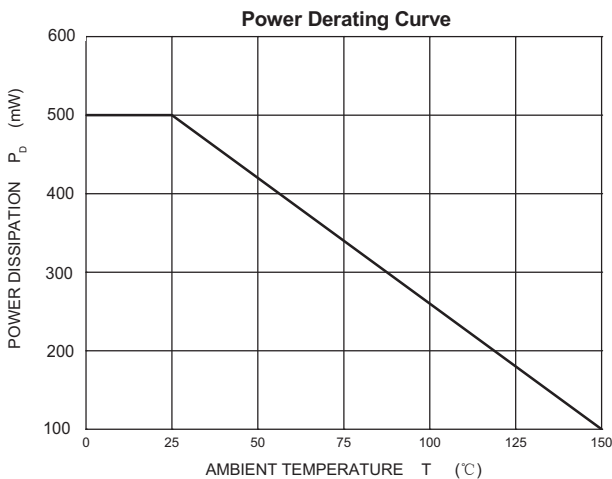
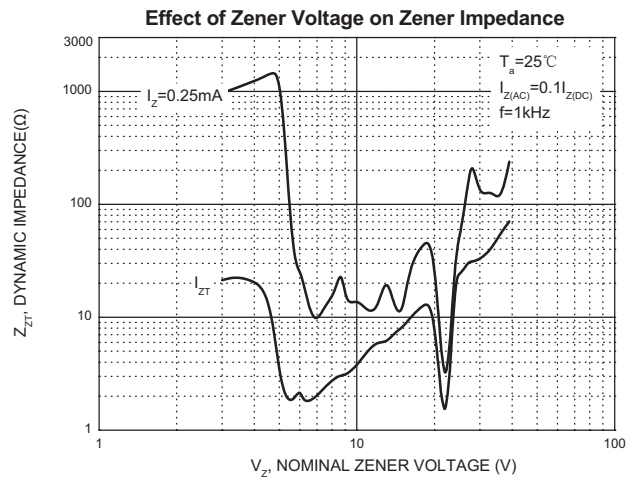
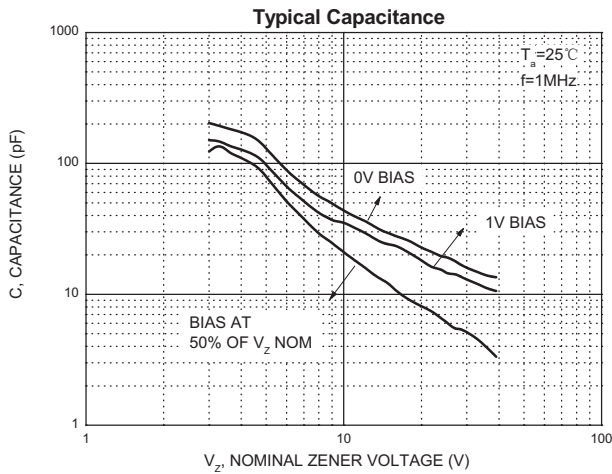
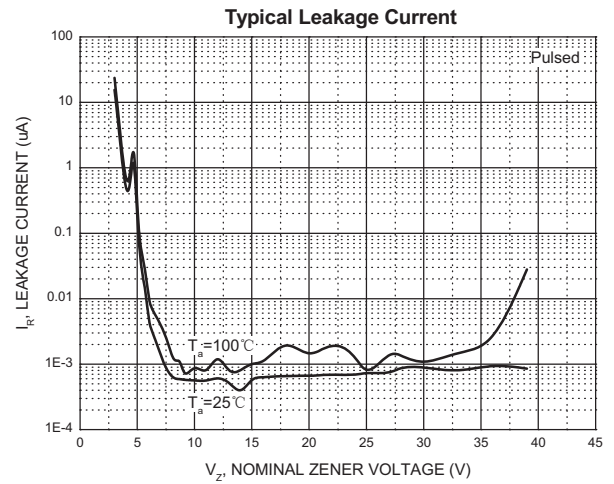
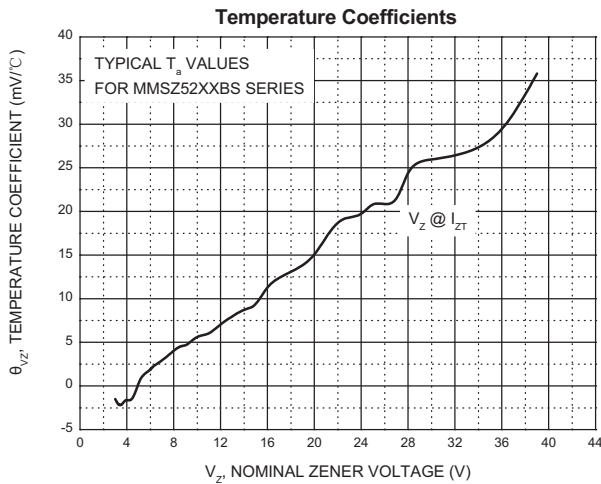
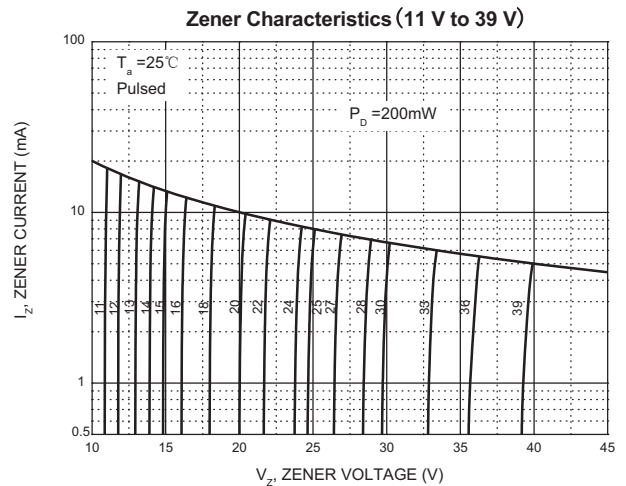
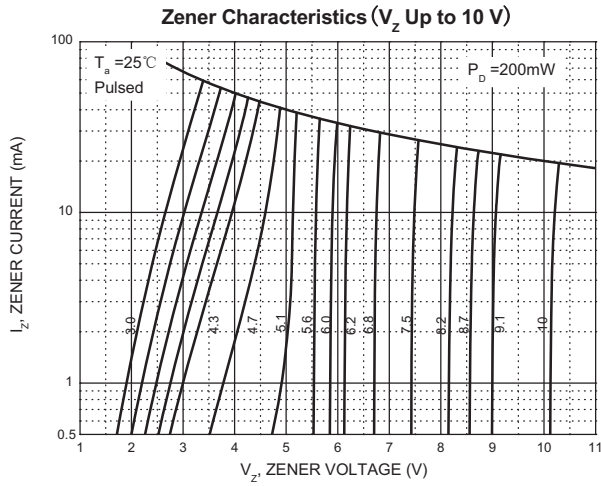



Attachment information about MMSZ5235BS

Marking on the body

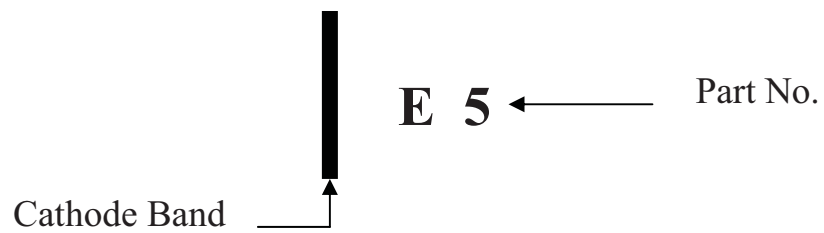

SOD-323 Package Outline Dimensions

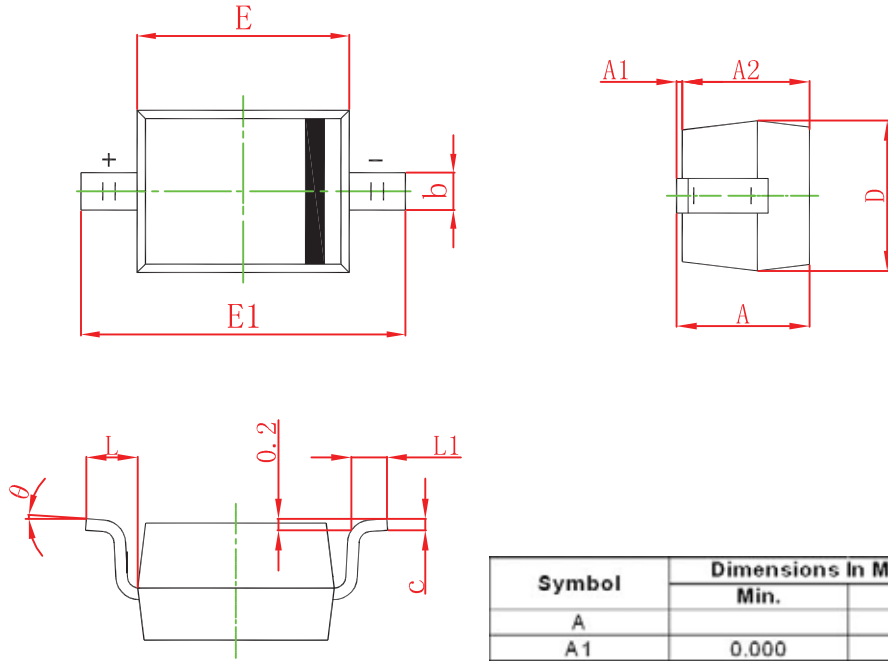

Symbol	Dimensions In Millimeters		Dimensions In Inches	
	Min.	Max.	Min.	Max.
A		1.000		0.039
A1	0.000	0.100	0.000	0.004
A2	0.800	0.900	0.031	0.035
b	0.250	0.350	0.010	0.014
c	0.080	0.150	0.003	0.006
D	1.200	1.400	0.047	0.055
E	1.600	1.800	0.063	0.071
E1	2.550	2.750	0.100	0.108
L	0.475 REF.		0.019 REF.	
L1	0.250	0.400	0.010	0.016
θ	0°	8°	0°	8°

SOD-323 Suggested Pad Layout

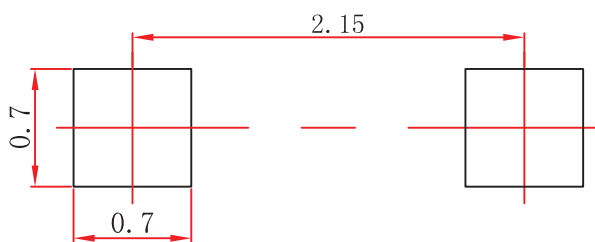

Note:

1. Controlling dimension: in millimeters.
2. General tolerance: ± 0.05 mm.
3. The pad layout is for reference purposes only.

SOD-323 Tape and Reel

SOD-323 Embossed Carrier Tape

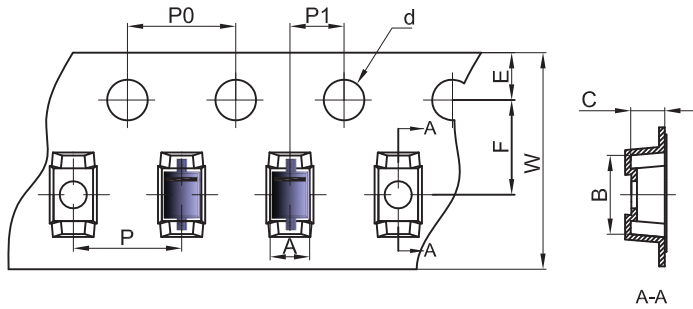

Packaging Description:

SOD-323 parts are shipped in tape. The carrier tape is made from a dissipative (carbon filled) polycarbonate resin. The cover tape is a multilayer film (Heat Activated Adhesive in nature) primarily composed of polyester film, adhesive layer, sealant, and anti-static sprayed agent. These reeled parts in standard option are shipped with 3,000 units per 7" or 17.8cm diameter reel. The reels are clear in color and is made of polystyrene plastic (anti-static coated).

Dimensions are in millimeter										
Pkg type	A	B	C	d	E	F	P0	P	P1	W
SOD-323	1.48	3.3	1.25	Ø1.50	1.75	3.50	4.00	4.00	2.00	8.00

SOD-323 Tape Leader and Trailer

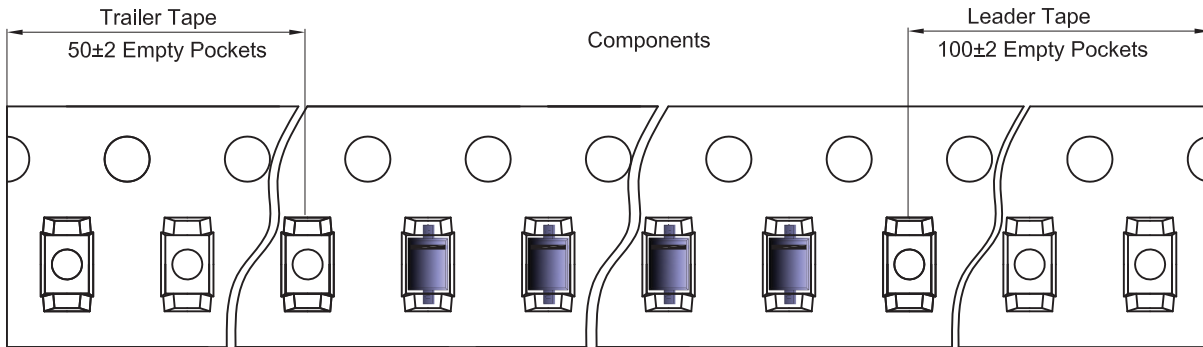

SOD-323 Reel

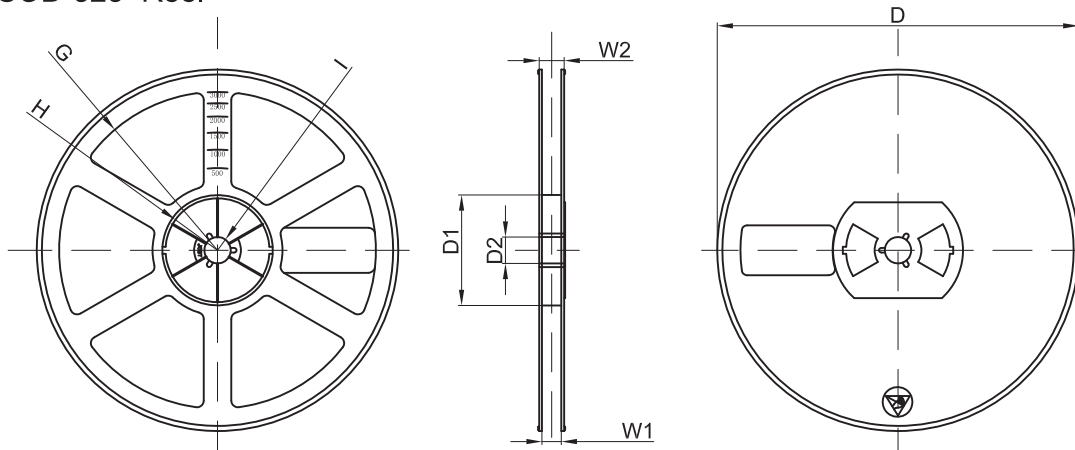

Dimensions are in millimeter								
Reel Option	D	D1	D2	G	H	I	W1	W2
7"Dia	Ø178.00	54.40	13.00	R78.00	R25.60	R6.50	9.50	12.30

REEL PACK

PACKAGE	PACKING CODE	EA PER REEL	EA PER INNER BOX	COMPONENT SPACE (mm)	TAPE SPACE (mm)	REEL DIA (mm)	CARTON SIZE (mm)	EA PER CARTON	GROSS WEIGHT(Kg)
SOD-323	-T	3,000	15,000	---	---	178	390*205*310	120,000	5.17

DISCLAIMER NOTICE

Rectron Inc reserves the right to make changes without notice to any product specification herein, to make corrections, modifications, enhancements or other changes. Rectron Inc or anyone on its behalf assumes no responsibility or liability for any errors or inaccuracies. Data sheet specifications and its information contained are intended to provide a product description only. "Typical" parameters which may be included on RECTRON data sheets and/ or specifications can and do vary in different applications and actual performance may vary over time. Rectron Inc does not assume any liability arising out of the application or use of any product or circuit.

Rectron products are not designed, intended or authorized for use in medical, life-saving implant or other applications intended for life-sustaining or other related applications where a failure or malfunction of component or circuitry may directly or indirectly cause injury or threaten a life without expressed written approval of Rectron Inc. Customers using or selling Rectron components for use in such applications do so at their own risk and shall agree to fully indemnify Rectron Inc and its subsidiaries harmless against all claims, damages and expenditures.