



## 3-Pin, Ultra-Low-Power SC70/SOT $\mu$ P Reset Circuits

### General Description

The MAX6326/MAX6327/MAX6328/MAX6346/MAX6347/MAX6348 microprocessor ( $\mu$ P) supervisory circuits monitor the power supplies in  $\mu$ P and digital systems. These devices provide excellent circuit reliability and low cost by eliminating external components and adjustments when used with 2.5V, 3V, 3.3V, and 5V powered circuits.

These circuits perform a single function: they assert a reset signal whenever the  $V_{CC}$  supply voltage declines below a preset threshold, keeping it asserted for at least 100ms after  $V_{CC}$  has risen above the reset threshold. The only difference between the devices is their output. The MAX6326/MAX6346 (push-pull) and MAX6328/MAX6348 (open-drain) have an active-low reset output. The MAX6327/MAX6347 have an active-high push-pull reset output. All of these parts are guaranteed to be in the correct state for  $V_{CC}$  down to 1V. The reset comparator is designed to ignore fast transients on  $V_{CC}$ . Reset thresholds are factory-trimmable between 2.2V and 4.63V, in approximately 100mV increments. Twenty-one standard versions are available. Contact the factory for availability of nonstandard versions.

Ultra-low supply currents (1 $\mu$ A max for the MAX6326/MAX6327/MAX6328) make these parts ideal for use in portable equipment. All six devices are available in space-saving SOT23 and SC70 packages.

### Applications

Computers	Intelligent Instruments
Controllers	Automotive
Critical $\mu$ P and $\mu$ C Power Monitoring	Portable/Battery-Powered Equipment

### Pin Configuration

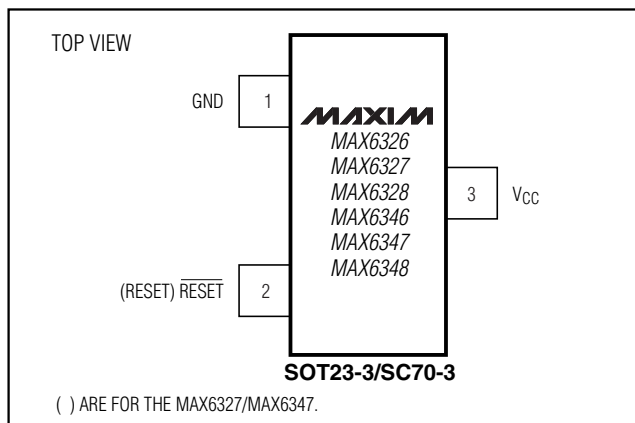

### Features

- ◆ Ultra-Low 1 $\mu$ A (max) Supply Current (MAX6326/MAX6327/MAX6328)
- ◆ Precision Monitoring of 2.5V, 3V, 3.3V, and 5V Power-Supply Voltages
- ◆ Reset Thresholds Available from 2.2V to 4.63V
- ◆ Fully Specified Over Temperature
- ◆ 100ms (min) Power-On Reset Pulse Width
- ◆ Low Cost
- ◆ Available in Three Versions: Push-Pull RESET, Push-Pull RESET, and Open-Drain RESET
- ◆ Power-Supply Transient Immunity
- ◆ No External Components
- ◆ 3-Pin SC70/SOT23 Packages
- ◆ Pin Compatible with MAX803/MAX809/MAX810

### Ordering Information

PART <sup>†</sup>	TEMP. RANGE	PIN-PACKAGE
MAX6326XR__-T	-40°C to +85°C	3 SC70-3
MAX6326UR__-T	-40°C to +85°C	3 SOT23-3
MAX6327XR__-T	-40°C to +85°C	3 SC70-3
MAX6327UR__-T	-40°C to +85°C	3 SOT23-3
MAX6328XR__-T	-40°C to +85°C	3 SC70-3
MAX6328UR__-T	-40°C to +85°C	3 SOT23-3
MAX6346XR__-T	-40°C to +85°C	3 SC70-3
MAX6346UR__-T	-40°C to +85°C	3 SOT23-3
MAX6347XR__-T	-40°C to +85°C	3 SC70-3
MAX6347UR__-T	-40°C to +85°C	3 SOT23-3
MAX6348XR__-T	-40°C to +85°C	3 SC70-3
MAX6348UR__-T	-40°C to +85°C	3 SOT23-3

<sup>†</sup>The MAX6326/MAX6327/MAX6328/MAX6346/MAX6347/MAX6348 are available in factory-set  $V_{CC}$  reset thresholds from 2.2V to 4.63V, in approximately 0.1V increments. Choose the desired reset-threshold suffix from Table 1 and insert it in the blank spaces following "R." There are 21 standard versions with a required order increment of 2500 pieces. Sample stock is generally held on the standard versions only (see the Selector Guide). Required order increment is 10,000 pieces for nonstandard versions (Table 2). Contact factory for availability. All devices available in tape-and-reel only.

Selector Guide appears at end of data sheet.



# 3-Pin, Ultra-Low-Power SC70/SOT $\mu$ P Reset Circuits

## ABSOLUTE MAXIMUM RATINGS

Terminal Voltage (with respect to GND)		Continuous Power Dissipation ( $T_A = +70^\circ\text{C}$ )
VCC .....	-0.3V to +6V	3-Pin SC70 (derate 2.7mW/ $^\circ\text{C}$ above +70 $^\circ\text{C}$ ) .....
RESET, RESET (push-pull) .....	-0.3V to (VCC + 0.3V)	3-Pin SOT23 (derate 4mW/ $^\circ\text{C}$ above +70 $^\circ\text{C}$ ) .....
RESET (open drain) .....	-0.3V to +6V	Operating Temperature Range .....
Input Current (VCC) .....	20mA	Storage Temperature Range .....
Output Current (RESET, RESET) .....	20mA	Lead Temperature (soldering, 10s) .....
Rate of Rise (VCC) .....	100V/ $\mu$ s	

Stresses beyond those listed under "Absolute Maximum Ratings" may cause permanent damage to the device. These are stress ratings only, and functional operation of the device at these or any other conditions beyond those indicated in the operational sections of the specifications is not implied. Exposure to absolute maximum rating conditions for extended periods may affect device reliability.

## ELECTRICAL CHARACTERISTICS

(VCC = full range,  $T_A = -40^\circ\text{C}$  to +85 $^\circ\text{C}$ , unless otherwise noted. Typical values are at  $T_A = +25^\circ\text{C}$  and VCC = 3V.) (Note 1)

PARAMETER	SYMBOL	CONDITIONS	MIN	TYP	MAX	UNITS	
VCC Range		$T_A = 0^\circ\text{C}$ to +70 $^\circ\text{C}$	1.0		5.5	V	
		$T_A = -40^\circ\text{C}$ to +85 $^\circ\text{C}$	1.2		5.5		
Supply Current	I <sub>CC</sub>	MAX632_ only, VCC = 3.0V for V <sub>TH</sub> ≤ 2.93V, VCC = 3.2V for V <sub>TH</sub> > 2.93V, no load		0.5	1.0	$\mu$ A	
		VCC = 5.5V, no load		1.0	1.75		
Reset Threshold	V <sub>TH</sub>	Table 1	$T_A = +25^\circ\text{C}$	V <sub>TH</sub> - 1.5%	V <sub>TH</sub>	V <sub>TH</sub> + 1.5%	V
			$T_A = -40^\circ\text{C}$ to +85 $^\circ\text{C}$	V <sub>TH</sub> - 2.5%	V <sub>TH</sub>	V <sub>TH</sub> + 2.5%	
Reset Threshold Tempco	$\Delta V_{TH}/^\circ\text{C}$			40		ppm/ $^\circ\text{C}$	
VCC to Reset Delay		VCC = V <sub>TH</sub> to (V <sub>TH</sub> - 100mV)		20		$\mu$ s	
Reset Active Timeout Period			100	185	280	ms	
RESET Output Voltage (MAX6326/MAX6328/MAX6346/MAX6348)	V <sub>OL</sub>	I <sub>SINK</sub> = 1.6mA, VCC > 2.1V, reset asserted			0.3	V	
		I <sub>SINK</sub> = 100 $\mu$ A, VCC ≥ 1.2V, reset asserted			0.4		
RESET Output Voltage (MAX6326/MAX6346)	V <sub>OH</sub>	I <sub>SOURCE</sub> = 500 $\mu$ A, VCC = 3.2V, MAX6326 only	0.8 · VCC			V	
		I <sub>SOURCE</sub> = 800 $\mu$ A, VCC = 4.5V, V <sub>TH</sub> ≤ 4.38V	0.8 · VCC				
		I <sub>SOURCE</sub> = 800 $\mu$ A, VCC = V <sub>TH</sub> (MAX), V <sub>TH</sub> ≥ 4.5V	0.8 · VCC				
RESET Output Voltage (MAX6327/MAX6347)	V <sub>OH</sub>	I <sub>SOURCE</sub> = 500 $\mu$ A, VCC ≥ 2.1V, reset asserted	0.8 · VCC			V	
		I <sub>SOURCE</sub> = 50 $\mu$ A, VCC ≥ 1.2V, reset asserted	0.8 · VCC				
	V <sub>OL</sub>	I <sub>SINK</sub> = 1.2mA, VCC ≥ 3.2V, reset not asserted, MAX6327 only			0.3		
		I <sub>SINK</sub> = 3.2mA, VCC ≥ 4.5V, reset not asserted, V <sub>TH</sub> ≤ 4.38V			0.4		
		I <sub>SINK</sub> = 3.2mA, VCC = V <sub>TH</sub> (MAX), V <sub>TH</sub> ≥ 4.5V			0.4		
RESET Threshold Hysteresis		MAX6326/MAX6327/MAX6328		6.3		mV	
		MAX6346/MAX6347/MAX6348		9.5			
Open-Drain RESET Output Leakage Current					0.1	$\mu$ A	

**Note 1:** Overtemperature limits are guaranteed by design and not production tested.

# 3-Pin, Ultra-Low-Power SC70/SOT $\mu$ P Reset Circuits

## Typical Operating Characteristics

( $T_A = +25^\circ\text{C}$ , unless otherwise noted.)

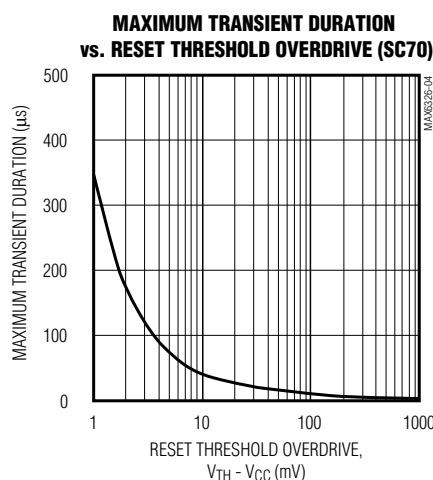
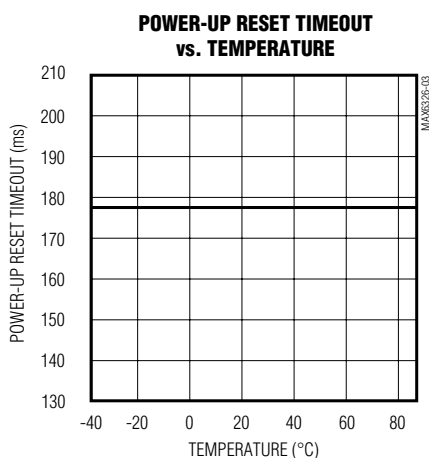
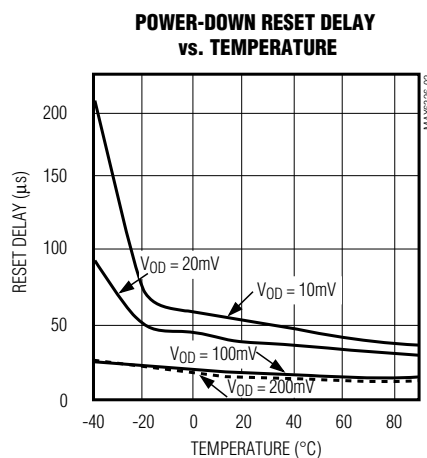
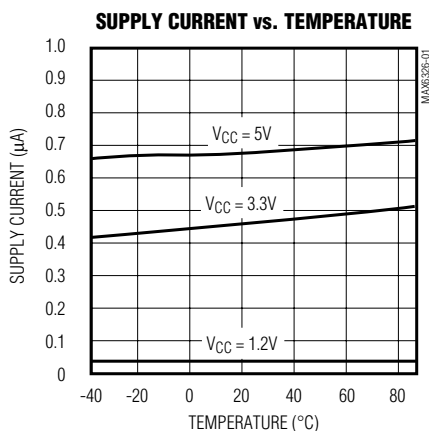

## Pin Description

PIN		NAME	FUNCTION
MAX6326/MAX6346 MAX6328/MAX6348	MAX6327 MAX6347		
1	1	GND	Ground
2	—	$\overline{\text{RESET}}$	Active-Low Reset Output. $\overline{\text{RESET}}$ remains low while $V_{CC}$ is below the reset threshold and for at least 100ms after $V_{CC}$ rises above the reset threshold. $\overline{\text{RESET}}$ is open-drain on the MAX6328/MAX6348 and push-pull on the MAX6326/MAX6346.
—	2	RESET	Active-High Reset Output. RESET remains high while $V_{CC}$ is below the reset threshold and for at least 100ms after $V_{CC}$ rises above the reset threshold.
3	3	$V_{CC}$	Supply Voltage

# 3-Pin, Ultra-Low-Power SC70/SOT $\mu$ P Reset Circuits

## Applications Information

### Interfacing to $\mu$ Ps with Bidirectional Reset Pins

Since the  $\overline{\text{RESET}}$  output on the MAX6328/MAX6348 is open drain, these devices interface easily with microprocessors ( $\mu$ Ps) that have bidirectional reset pins, such as the Motorola 68HC11. Connecting the  $\mu$ P supervisor's  $\overline{\text{RESET}}$  output directly to the microcontroller's ( $\mu$ C's)  $\overline{\text{RESET}}$  pin with a single pull-up resistor allows either device to assert reset (Figure 1).

### Negative-Going Vcc Transients

In addition to issuing a reset to the  $\mu$ P during power-up, power-down, and brownout conditions, these devices are relatively immune to short-duration, negative-going Vcc transients (glitches).

The *Typical Operating Characteristics* show the Maximum Transient Duration vs. Reset Threshold Overdrive graph, for which reset pulses are not generated. The graph shows the maximum pulse width that a negative-going Vcc transient may typically have when issuing a reset signal. As the amplitude of the transient increases, the maximum allowable pulse width decreases.

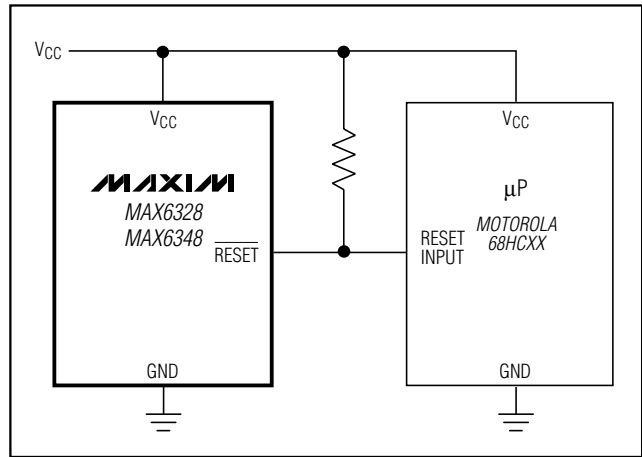

Figure 1. Interfacing to  $\mu$ Ps with Bidirectional Reset Pins

Table 1. Factory-Trimmed Reset Thresholds $\ddagger$

PART	SUFFIX	RESET THRESHOLD VOLTAGE, $V_{TH}$ (V)				
		$T_A = +25^\circ\text{C}$			$T_A = -40^\circ\text{C to } +85^\circ\text{C}$	
		MIN	TYP	MAX	MIN	MAX
MAX632_ _R	22	2.167	2.200	2.233	2.145	2.250
MAX632_ _R	23	2.285	2.320	2.355	2.262	2.375
MAX632_ _R	24	2.364	2.400	2.436	2.340	2.460
MAX632_ _R	25	2.462	2.500	2.537	2.437	2.562
MAX632_ _R	26	2.591	2.630	2.669	2.564	2.696
MAX632_ _R	27	2.660	2.700	2.741	2.633	2.768
MAX632_ _R	28	2.758	2.800	2.842	2.730	2.870
MAX632_ _R	29	2.886	2.930	2.974	2.857	3.000
MAX632_ _R	30	2.955	3.000	3.045	2.925	3.075
MAX632_ _R	31	3.034	3.080	3.126	3.003	3.150
MAX634_ _R	33	3.250	3.300	3.350	3.217	3.383
MAX634_ _R	34	3.349	3.400	3.451	3.315	3.485
MAX634_ _R	35	3.447	3.500	3.552	3.412	3.587
MAX634_ _R	36	3.546	3.600	3.654	3.510	3.690
MAX634_ _R	37	3.644	3.700	3.755	3.607	3.792
MAX634_ _R	38	3.743	3.800	3.857	3.705	3.895

$\ddagger$ Factory-trimmed reset thresholds are available in approximately 100mV increments with a 1.5% room-temperature variance.

# 3-Pin, Ultra-Low-Power SC70/SOT μP Reset Circuits

**Table 1. Factory-Trimmed Reset Thresholds‡ (continued)**

PART	SUFFIX	RESET THRESHOLD VOLTAGE, V <sub>TH</sub> (V)				
		T <sub>A</sub> = +25°C			T <sub>A</sub> = -40°C to +85°C	
		MIN	TYP	MAX	MIN	MAX
MAX634_R	39	3.841	3.900	3.958	3.802	3.997
MAX634_R	40	3.940	4.000	4.060	3.900	4.100
MAX634_R	41	4.038	4.100	4.161	3.997	4.202
MAX634_R	42	4.137	4.200	4.263	4.095	4.305
MAX634_R	43	4.235	4.300	4.364	4.192	4.407
MAX634_R	44	4.314	4.380	4.446	4.270	4.489
MAX634_R	45	4.432	4.500	4.567	4.387	4.612
MAX634_R	46	4.560	4.630	4.699	4.514	4.746

‡Factory-trimmed reset thresholds are available in approximately 100mV increments with a 1.5% room-temperature variance.

**Table 2. Device Marking Codes and Minimum Order Increments**

PART	TOP MARK		ORDER INCREMENT (k)
	SOT23	SC70	
<b>MAX6346</b> _R46-T	FZBI	ACO	2.5
MAX6346_R45-T	FZBH	–	10
MAX6346_R44-T	FZBG	ACK	2.5
MAX6346_R43-T	FZBF	–	10
MAX6346_R42-T	FZBE	–	10
MAX6346_R41-T	FZBD	–	10
MAX6346_R40-T	FZBC	–	10
MAX6346_R39-T	FZBB	–	10
MAX6346_R38-T	FZBA	–	10
MAX6346_R37-T	FZAZ	–	10
MAX6346_R36-T	FZAY	–	10
MAX6346_R35-T	FZAX	–	10
MAX6346_R34-T	FZAW	–	10
MAX6346_R33-T	FZAV	–	10
<b>MAX6326</b> _R31-T	FDA A	ACE	2.5
MAX6326_R30-T	FEAA	–	10
MAX6326_R29-T	FCAA	ACP	2.5
MAX6326_R28-T	FBAA	–	10
MAX6326_R27-T	FAAA	–	10
MAX6326_R26-T	EZAA	ACI	2.5
MAX6326_R25-T	EYAA	–	10
MAX6326_R24-T	EXAA	–	10
MAX6326_R23-T	EWAA	ACH	2.5
MAX6326_R22-T	EHAA	AAH	2.5

PART	TOP MARK		ORDER INCREMENT (k)
	SOT23	SC70	
<b>MAX6347</b> _R46-T	FZBW	ACF	2.5
MAX6347_R45-T	FZBV	–	10
MAX6347_R44-T	FZBU	ACL	2.5
MAX6347_R43-T	FZBT	–	10
MAX6347_R42-T	FZBS	–	10
MAX6347_R41-T	FZBR	–	10
MAX6347_R40-T	FZBQ	–	10
MAX6347_R39-T	FZBP	–	10
MAX6347_R38-T	FZBO	–	10
MAX6347_R37-T	FZBN	–	10
MAX6347_R36-T	FZBM	–	10
MAX6347_R35-T	FZBL	–	10
MAX6347_R34-T	FZBK	–	10
MAX6347_R33-T	FZBJ	–	10
<b>MAX6327</b> _R31-T	FMAA	ACT	2.5
MAX6327_R30-T	FNAA	–	10
MAX6327_R29-T	FLAA	ACS	2.5
MAX6327_R28-T	FKAA	–	10
MAX6327_R27-T	FJAA	–	10
MAX6327_R26-T	FIAA	ACR	2.5
MAX6327_R25-T	FHAA	–	10
MAX6327_R24-T	FGAA	–	10
MAX6327_R23-T	FFAA	ACQ	2.5
MAX6327_R22-T	EIAA	AAI	2.5

# 3-Pin, Ultra-Low-Power SC70/SOT $\mu$ P Reset Circuits

Table 2. Device Marking Codes and Minimum Order Increments (continued)

PART	TOP MARK		ORDER INCREMENT (k)
	SOT23	SC70	
MAX6348_R46-T	FZCK	ACN	2.5
MAX6348_R45-T	FZCJ	–	10
MAX6348_R44-T	FZCI	ACM	2.5
MAX6348_R43-T	FZCH	–	10
MAX6348_R42-T	FZCG	–	10
MAX6348_R41-T	FZCF	–	10
MAX6348_R40-T	FZCE	–	10
MAX6348_R39-T	FZCD	–	10
MAX6348_R38-T	FZCC	–	10
MAX6348_R37-T	FZCB	–	10
MAX6348_R36-T	FZCA	–	10
MAX6348_R35-T	FZBZ	–	10

PART	TOP MARK		ORDER INCREMENT (k)
	SOT23	SC70	
MAX6348_R34-T	FZBY	–	10
MAX6348_R33-T	FZBX	–	10
MAX6328_R31-T	FVAA	ACW	2.5
MAX6328_R30-T	FWAA	–	10
MAX6328_R29-T	FUAA	ACV	2.5
MAX6328_R28-T	FTAA	–	10
MAX6328_R27-T	FSAA	–	10
MAX6328_R26-T	FRAA	ACJ	2.5
MAX6328_R25-T	FQAA	–	10
MAX6328_R24-T	FPAA	–	10
MAX6328_R23-T	FOAA	ACU	2.5
MAX6328_R22-T	EJAA	AAJ	2.5

## Selector Guide (standard versions\*)

PART	NOMINAL $V_{TH}$ (V)
MAX634_ _R46-T	4.63
MAX634_ _R44-T	4.38
MAX632_ _R31-T	3.08
MAX632_ _R29-T	2.93
MAX632_ _R26-T	2.63
MAX632_ _R23-T	2.32
MAX632_ _R22-T	2.20

\*Sample stock is generally held on all standard versions.

## Chip Information

TRANSISTOR COUNT: 419

# 3-Pin, Ultra-Low-Power SC70/SOT $\mu$ P Reset Circuits

## Package Information

NOTES:

1. D&E DO NOT INCLUDE MOLD FLASH.
2. MOLD FLASH OR PROTRUSIONS NOT TO EXCEED .15mm (.006")
3. CONTROLLING DIMENSION: MILLIMETER

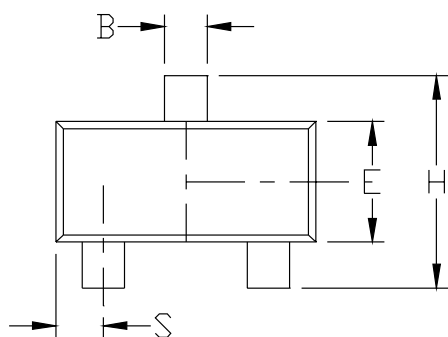

DIM	INCHES		MILLIMETERS	
	MIN	MAX	MIN	MAX
A	0.031	0.047	0.787	1.194
A1	0.001	0.005	0.025	0.127
B	0.014	0.022	0.356	0.559
C	0.0034	0.006	0.086	0.152
D	0.105	0.120	2.667	3.048
E	0.047	0.055	1.194	1.397
e	0.070	0.080	1.778	2.032
H	0.082	0.098	2.083	2.489
L	0.004	0.012	0.102	0.305
S	0.017	0.022	0.432	0.559
$\alpha$	0°	8°	0°	8°

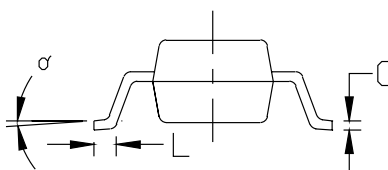
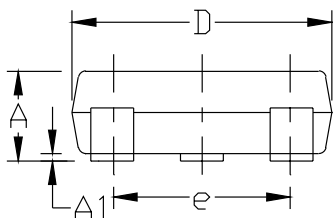

<b>MAXIM</b>			
<small>PROPRIETARY INFORMATION</small>			
<small>TITLE:</small>			
PACKAGE OUTLINE, SOT-23, 3L			
<small>APPROVAL</small>	<small>DOCUMENT CONTROL NO.</small>	<small>REV</small>	<small>1/1</small>
	21-0051	C	

SOT23-3L

MAX6326/MAX6327/MAX6328/MAX6346/MAX6347/MAX6348

# 3-Pin, Ultra-Low-Power SC70/SOT μP Reset Circuits

## Package Information (continued)

SYMBOL	MIN	MAX
e	0.65	BSC
D	1.80	2.20
b	0.25	0.40
E	1.15	1.35
HE	1.80	2.40
Q1	0.10	0.40
A2	0.80	1.00
A1	0.00	0.10
A	0.80	1.10
c	0.10	0.18
L	0.10	0.30
L1	0.425	TYP.

NOTE:

1. ALL DIMENSIONS ARE IN MILLIMETERS
2. DIMENSIONS ARE INCLUSIVE OF PLATING
3. DIMENSIONS ARE EXCLUSIVE OF MOLD FLASH & METAL BURR
4. ALL SPECIFICATIONS COMPLY TO EIAJ SC70
5. COPLANARITY 4 MILS. MAX.

<b>MAXIM</b>		
<small>PROPRIETARY INFORMATION</small>		
<small>TITLE:</small>		
PACKAGE OUTLINE, SC70, 3L		
<small>APPROVAL</small>	<small>DOCUMENT CONTROL NO.</small>	<small>REV</small>
	21-0075	A 1/1

SC70, 3L EFS

Maxim cannot assume responsibility for use of any circuitry other than circuitry entirely embodied in a Maxim product. No circuit patent licenses are implied. Maxim reserves the right to change the circuitry and specifications without notice at any time.

8 Maxim Integrated Products, 120 San Gabriel Drive, Sunnyvale, CA 94086 408-737-7600