



ULTRA LOW NOISE, HIGH IP3

# Monolithic Amplifier PMA2-162LN+

50Ω 0.7 to 1.6 GHz

## THE BIG DEAL

- Ultra Low Noise Figure, 0.5 dB at 1 GHz
- High IP3, 30 dBm typ. at 1 GHz
- Class 1B HBM ESD (500V)
- Adjustable gain, 19.7-23.5 dB at 1 GHz
- High Pout, P1dB 20 dBm typ. at 1 GHz
- May be used as a replacement for MGA-631P8 <sup>a,b</sup>

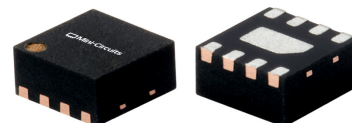

Generic photo used for illustration purposes only

CASE STYLE: MC1631

**+RoHS Compliant**

The +Suffix identifies RoHS Compliance. See our web site for RoHS Compliance methodologies and qualifications

## APPLICATIONS

- Base station infrastructure
- Portable Wireless
- LTE
- GPS
- GSM
- Airborne radar

## PRODUCT OVERVIEW

Mini-Circuits PMA2-162LN+ is a E-PHEMT\* based Ultra-Low Noise MMIC Amplifier with a unique combinations of low noise and high IP3 making this amplifier ideal for sensitive high dynamic range receiver applications. This design operates on a single 4V supply.

## KEY FEATURES

Feature	Advantages
Ultra Low Noise, 0.5 dB at 1.0 GHz	Outstanding world class noise figure performance.
High IP3, +30 dBm at 1.0 GHz	Combining Low Noise and High IP3 makes this MMIC amplifier ideal for use in Low Noise Receiver Front End (RFE) as it gives the user advantages at both ends of the dynamic range: sensitivity & two-tone IM performance.
Adjustable Gain	By changing feedback resistor R1, gain can be changed from 19.7 to 23.5 dB at 1GHz
2mm x 2mm 8 lead MCLP Package	Low Inductance, repeatable transitions, excellent thermal contact to PCB
Max Input Power, +25 dBm	Ruggedized design operates up to high input powers often seen at Receiver inputs eliminating the need for an external resistor.
High Reliability	Low, small signal operating current of 55 mA nominal maintains junction temperatures typically below 100°C at 85°C ground lead temperature.
Class 1B ESD (500V HBM)	The PMA2-162LN+ is a super low noise PHEMT based design. Mini-Circuits incorporates ESD protection on die to achieve industry leading ESD performance for a low noise amplifier.

A. Suitability for model replacement within a particular system must be determined by and is solely the responsibility of the customer based on, among other things, electrical performance criteria, stimulus conditions, application, compatibility with other components and environmental conditions and stresses.

B. The Avago MGA-631P8 part number is used for identification and comparison purposes only.

\*Enhancement mode Pseudomorphic High Electron Mobility Transistor





ULTRA LOW NOISE, HIGH IP3

# Monolithic Amplifier PMA2-162LN+

**ELECTRICAL SPECIFICATIONS<sup>1,2</sup> AT 25°C AND 4V, UNLESS NOTED OTHERWISE**

Parameter	Condition (GHz)	R1=267Ω1			R1=93Ω2			Units
		Min.	Typ.	Max.	Min.	Typ.	Max.	
Frequency Range		0.7		1.6	0.7		1.6	GHz
Noise Figure	0.7		0.55			0.57		dB
	0.8		0.51			0.54		
	1.0		0.47			0.48		
	1.3		0.64			0.65		
	1.6		0.80			0.81		
Gain	0.7	—	24.4	—	—	22.7	23.1	dB
	0.8	—	24.1	—	—	22.2		
	1.0	20.9	22.7	24.5	18.6	20.8		
	1.3	—	20.7	—	—	19.1		
	1.6	—	18.8	—	—	17.7		
Input Return Loss	0.7		9.5			11.5	dB	
	0.8		15.5			18.8		
	1.0		17.9			20.0		
	1.3		12.4			14.5		
	1.6		10.8			12.4		
Output Return Loss	0.7		13.6			21.6	dB	
	0.8		16.1			17.8		
	1.0		18.9			16.0		
	1.3		15.6			15.1		
	1.6		10.7			11.6		
Output Power @1 dB compression <sup>3</sup>	0.7		19.5			18.3	dBm	
	0.8		19.8			18.9		
	1.0		19.9			19.7		
	1.3		19.7			19.8		
	1.6		18.8			19.0		
Output IP3	0.7		29.1			28.3	dBm	
	0.8		30.3			29.5		
	1.0		30.0			29.0		
	1.3		30.1			29.2		
	1.6		29.4			28.5		
Device Operating Voltage		3.8	4.0	4.2	3.8	4.0	4.2	V
Device Operating Current at 4V			55	60		55	60	mA
Device Current Variation vs. Temperature at 4V <sup>4</sup>			2			2		μA/°C
Device Current Variation vs Voltage at 25°C			0.016			0.016		mA/mV
Thermal Resistance, junction-to-ground lead			53			53		°C/W

1. Measured on Mini-Circuits Characterization test board TB-615+. See Characterization Test Circuit (Fig. 1) R1=267Ω
2. Measured on Mini-Circuits Characterization test board TB-615+. See Characterization Test Circuit (Fig. 1) R1=93Ω
3. Current increases at P1dB
4. (Current at 85°C - Current at -45°C)/130

**MAXIMUM RATINGS**

Parameter	Ratings
Operating Temperature (ground lead)	-40°C to 85°C
Storage Temperature	-65°C to 150°C
Junction Temperature	150°C
Total Power Dissipation	0.55 W
Input Power (CW), Vd=4V	25 dBm
DC Voltage	5.5V

Permanent damage may occur if any of these limits are exceeded. Electrical maximum ratings are not intended for continuous normal operation.

**DC CURRENT HISTOGRAM**

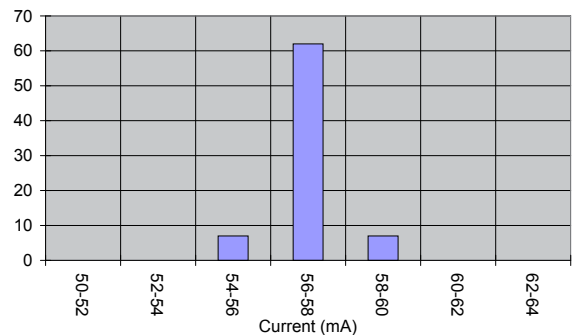



ULTRA LOW NOISE, HIGH IP3

# Monolithic Amplifier PMA2-162LN+

## SIMPLIFIED SCHEMATIC & PAD CONNECTIONS

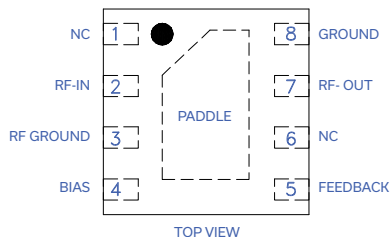
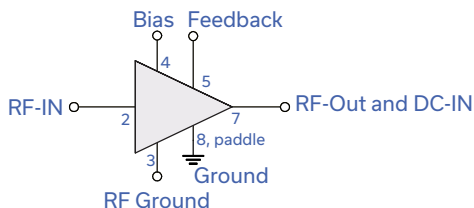

Function	Pad Number	Description
RF IN	2	Connects to RF input via C1 and Pad 3 via L1
RF-OUT & DC-IN	7	Connects to RF out via C2, Pad 5 via R1, and C3
RF-Ground	3	Connects to ground via C4 and Pad 2 via L1
Bias	4	Connects to Supply voltage (Vs) via Rbias
Feedback	5	Connected to pads 7, 4 via R1 and C3
No Connection	1,6	Not used internally. Pin 1 Connected to ground on test board
Ground	8 & paddle	Connects to ground

## RECOMMENDED APPLICATION AND CHARACTERIZATION TEST CIRCUIT

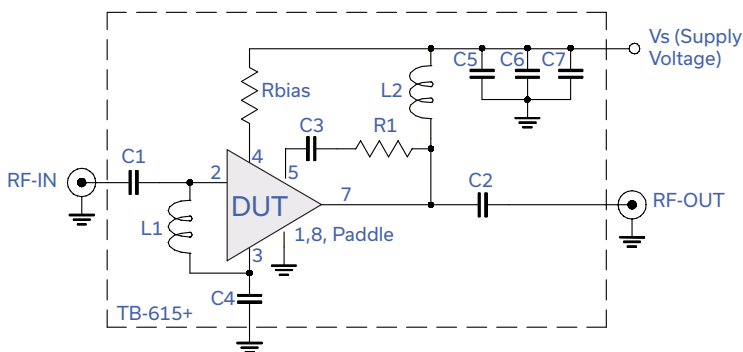

Fig 1. Application and Characterization circuit

Note: This block diagram is used for characterization. (DUT soldered on Mini-Circuits Characterization test board TB-615+)

Gain, Return loss, Output power at 1dB compression (P1 dB), output IP3 (OIP3) and noise figure measured using Agilent's N5242A PNA-X microwave network analyzer.

Conditions:

1. Gain and Return loss: Pin = -25dBm
2. Output IP3 (OIP3): Two tones, spaced 1 MHz apart, 0 dBm/tone at output.

Components	Size	Value	Manufacturer	P/N
C1, C6	0402	9.1pF	AVX CORP	04025U9R1CAT2A
C2, C4	0402	100pF	Murata	GRM1555C1H101JA01D
C3	0402	5.6pF	Murata	GJM1555C1H5R6BB01D
C5, C7	0402	0.1uF	Murata	GRM155R71C104KA88D
R1	0402	267 Ohm	KOA Speer Electronics	RK73H1ETTP2670F
Rbias	0402	750 Ohm	KOA Speer Electronics	RK73H1ETTP7500F
L1	0402	6.8nH	Coilcraft, Inc.	0402CS-6N8XGLW
L2	0402	15nH	Coilcraft, Inc.	0402CS-15NXGLW

## PRODUCT MARKING

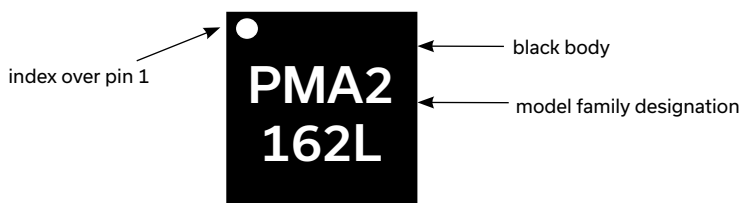

Marking may contain other features or characters for internal lot control





ULTRA LOW NOISE, HIGH IP3

# Monolithic Amplifier PMA2-162LN+

## ADJUSTABLE GAIN PERFORMANCE (VS. R1)

S21 (AMPLITUDE,dB) Vs. Frequency and R1 Values

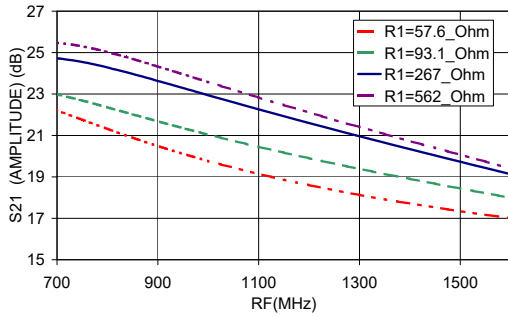

NOISE FIGURE (dB) Vs. Frequency and R1 Values

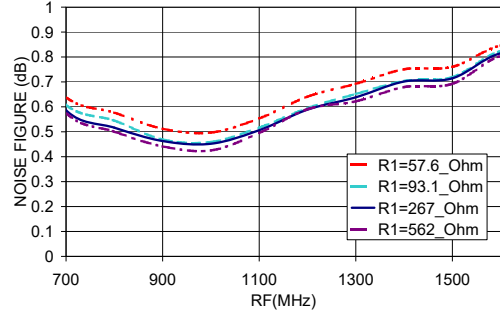

S22 (AMPLITUDE,dB) Vs. Frequency and R1 Values

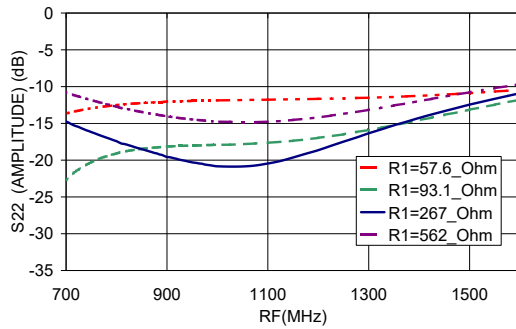

S11 (AMPLITUDE,dB) Vs. Frequency and R1 Values

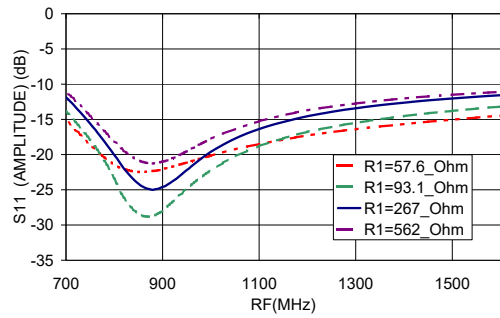



ULTRA LOW NOISE, HIGH IP3

# Monolithic Amplifier PMA2-162LN+

ADDITIONAL DETAILED TECHNICAL INFORMATION IS AVAILABLE ON OUR DASH BOARD. TO ACCESS [CLICK HERE](#)

<b>Performance Data</b>	Data Table Swept Graphs S-Parameter (S2P Files) Data Set (.zip file)
<b>Case Style</b>	MC1631 Plastic package, exposed paddle, lead finish: matte tin
<b>Tape &amp; Reel</b>	F108
<b>Standard quantities available on reel</b>	7" reels with 20, 50, 100, 200, 500,1K, 2K or 3K devices
<b>Suggested Layout for PCB Design</b>	PL-344
<b>Evaluation Board</b>	TB-615+
<b>Environmental Ratings</b>	ENV08T1

### ESD RATING

Human Body Model (HBM): Class 1B (500 to <1000V) in accordance with ANSI/ESD STM 5.1 - 2001

Machine Model (MM): Class M1 (pass 25V) in accordance with ANSI/ESD STM5.2-1999

### MSL RATING

Moisture Sensitivity: MSL1 in accordance with IPC/JEDEC J-STD-020D

### MSL TEST FLOW CHART

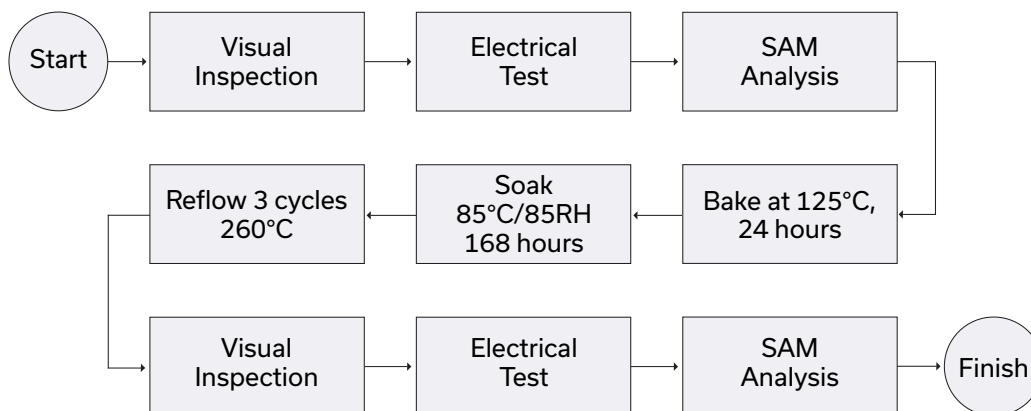

#### NOTES

- A. Performance and quality attributes and conditions not expressly stated in this specification document are intended to be excluded and do not form a part of this specification document.
- B. Electrical specifications and performance data contained in this specification document are based on Mini-Circuit's applicable established test performance criteria and measurement instructions.
- C. The parts covered by this specification document are subject to Mini-Circuits standard limited warranty and terms and conditions (collectively, "Standard Terms"); Purchasers of this part are entitled to the rights and benefits contained therein. For a full statement of the standard. Terms and the exclusive rights and remedies thereunder, please visit Mini-Circuits' website at [www.minicircuits.com/MCLStore/terms.jsp](http://www.minicircuits.com/MCLStore/terms.jsp)

