

# C1608CH2A680J080AA

TDK Item Description : C1608CH2A680JT\*\*\*



## Application & Main Feature

Commercial Grade ( Mid Voltage (100 to 630V) )

## Series

C1608 [EIA CC0603]

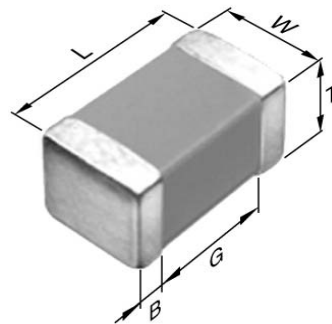

## Dimensions

L 1.60mm +/-0.1mm  
 W 0.80mm +/-0.1mm  
 T 0.80mm +/-0.1mm  
 B 0.20mm Min.  
 G 0.30mm Min.

## Temperature Characteristic

CH (-25 to 85 degC 0+/-60ppm/degC)

## Rated Voltage

2A (100Vdc)

## Capacitance

68pF

## Capacitance Tolerance

J (+/-5%)

## Q Factor

1000 Min.

## Insulation Resistance

10Gohm Min.

## AEC-Q200

Not Applicable

**|Z|, ESR vs. Freq. Characteristics**

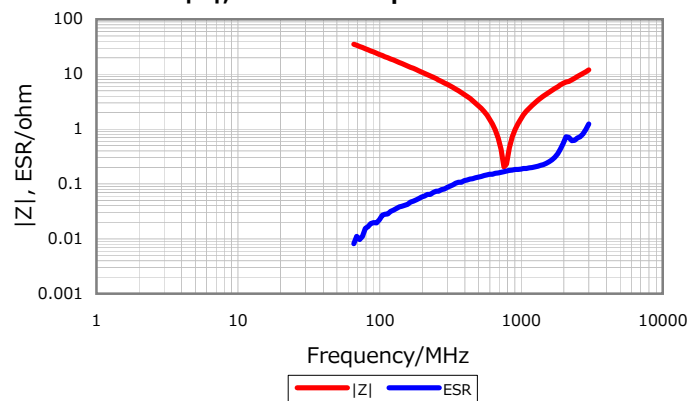

**DC Bias Characteristic**

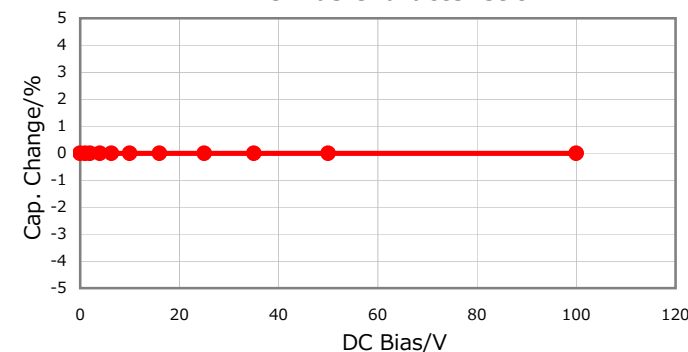

**Cap. vs. Freq. Characteristic**

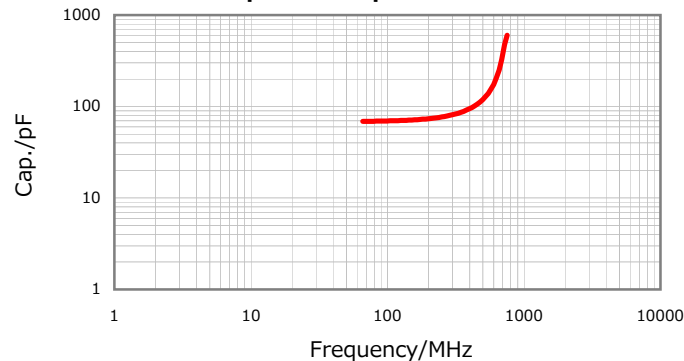

**Temperature Characteristics**

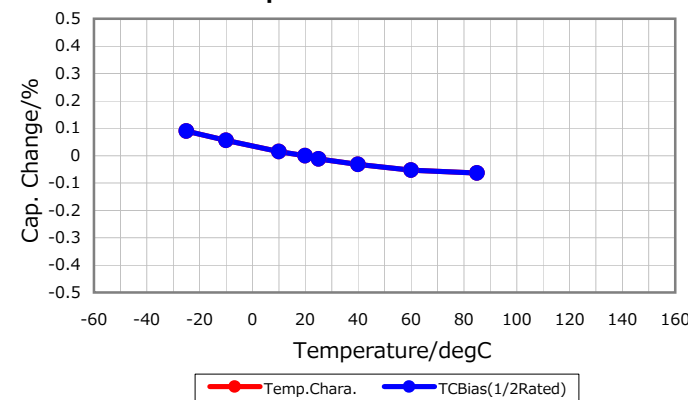

Characterization Sheet ( Multilayer Ceramic Chip Capacitors )



All specifications are subject to change without notice.

January 3, 2016