

HEXFET® Power MOSFET

- Advanced Process Technology
- Ultra Low On-Resistance
- Dual N and P Channel Mosfet
- Surface Mount
- Available in Tape & Reel
- Dynamic dv/dt Rating
- Fast Switching

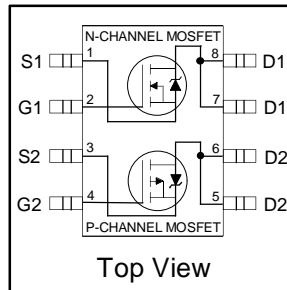

	N-Ch	P-Ch
V_{DSS}	20V	-20V
$R_{DS(on)}$	0.125 Ω	0.20 Ω
I_D	3.0A	-2.5A

Description

Fourth Generation HEXFETs from International Rectifier utilize advanced processing techniques to achieve the lowest possible on-resistance per silicon area. This benefit, combined with the fast switching speed and ruggedized device design for which HEXFET Power MOSFETs are well known, provides the designer with an extremely efficient device for use in a wide variety of applications.

The SO-8 has been modified through a customized leadframe for enhanced thermal characteristics and multiple-die capability making it ideal in a variety of power applications. With these improvements, multiple devices can be used in an application with dramatically reduced board space. The package is designed for vapor phase, infra-red, or wave soldering techniques. Power dissipation of greater than 0.8W is possible in a typical PCB mount application.

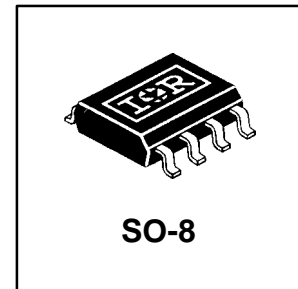

Absolute Maximum Ratings

	Parameter	Max.		Units
		N-Channel	P-Channel	
$I_D @ T_C = 25^\circ\text{C}$	Continuous Drain Current, $V_{GS} @ 10\text{V}$	3.0	-2.5	A
$I_D @ T_C = 70^\circ\text{C}$	Continuous Drain Current, $V_{GS} @ 10\text{V}$	2.5	-2.0	
I_{DM}	Pulsed Drain Current ^①	10	-10	
$P_D @ T_C = 25^\circ\text{C}$	Power Dissipation	2.0		W
	Linear Derating Factor	0.016		W/ $^\circ\text{C}$
V_{GS}	Gate-to-Source Voltage	± 20		V
dv/dt	Peak Diode Recovery dv/dt ^②	3.0	-3.0	V/ns
T_J, T_{STG}	Junction and Storage Temperature Range	-55 to + 150		$^\circ\text{C}$

Thermal Resistance

	Parameter	Min.	Typ.	Max.	Units
$R_{\theta JA}$	Junction-to-Ambient (PCB Mount)**	—	—	62.5	$^\circ\text{C}/\text{W}$

** When mounted on 1" square PCB (FR-4 or G-10 Material).
For recommended footprint and soldering techniques refer to application note #AN-994.

Electrical Characteristics @ T_J = 25°C (unless otherwise specified)

Parameter	Parameter		Min.	Typ.	Max.	Units	Conditions	
							N-Ch	P-Ch
V _{(BR)DSS}	Drain-to-Source Breakdown Voltage		20	—	—	V	V _{GS} = 0V, I _D = 250μA	
			-20	—	—		V _{GS} = 0V, I _D = -250μA	
ΔV _{(BR)DSS} /ΔT _J	Breakdown Voltage Temp. Coefficient		—	0.037	—	V/°C	Reference to 25°C, I _D = 1mA	
			—	-0.022	—		Reference to 25°C, I _D = -1mA	
R _{DS(ON)}	Static Drain-to-Source On-Resistance	N-Ch	—	—	0.125	Ω	V _{GS} = 10V, I _D = 1.0A ③	
			—	—	0.25		V _{GS} = 4.5V, I _D = 0.50A ③	
		P-Ch	—	—	0.20		V _{GS} = -10V, I _D = -1.0A ③	
			—	—	0.35		V _{GS} = -4.5V, I _D = -0.50A ③	
V _{GS(th)}	Gate Threshold Voltage		1.0	—	—	V	V _{DS} = V _{GS} , I _D = 250μA	
			-1.0	—	—		V _{DS} = V _{GS} , I _D = -250μA	
g _{fs}	Forward Transconductance	N-Ch	—	4.4	—	S	V _{DS} = 15V, I _D = 3.0A ③	
		P-Ch	—	3.0	—		V _{DS} = -15V, I _D = -3.0A ③	
I _{DSS}	Drain-to-Source Leakage Current	N-Ch	—	—	2.0	μA	V _{DS} = 16V, V _{GS} = 0V	
		P-Ch	—	—	-2.0		V _{DS} = -16V, V _{GS} = 0V	
		N-Ch	—	—	25		V _{DS} = 16V, V _{GS} = 0V, T _J = 125°C	
		P-Ch	—	—	-25		V _{DS} = -16V, V _{GS} = 0V, T _J = 125°C	
I _{GSS}	Gate-to-Source Forward Leakage	N-P	—	—	±100	nA	V _{GS} = ± 20V	
Q _g	Total Gate Charge	N-Ch	—	9.1	25		N-Channel I _D = 2.3A, V _{DS} = 10V, V _{GS} = 10V	
		P-Ch	—	11	25			
Q _{gs}	Gate-to-Source Charge	N-Ch	—	1.2	—		P-Channel I _D = -2.3A, V _{DS} = -10V, V _{GS} = -10V	③
		P-Ch	—	1.6	—			
Q _{gd}	Gate-to-Drain ("Miller") Charge	N-Ch	—	2.5	—			
		P-Ch	—	3.5	—			
t _{d(on)}	Turn-On Delay Time		—	5.0	15		N-Channel V _{DD} = 20V, I _D = 1.0A, R _G = 6.0Ω, R _D = 20Ω	③
			—	10	40			
t _r	Rise Time	N-Ch	—	10	20			
		P-Ch	—	15	40			
t _{d(off)}	Turn-Off Delay Time	N-Ch	—	29	50		P-Channel V _{DD} = -20V, I _D = -1.0A, R _G = 6.0Ω, R _D = 20Ω	
		P-Ch	—	41	90			
t _f	Fall Time	N-Ch	—	22	50			
		P-Ch	—	39	60			
L _D	Internal Drain Inductance	N-P	—	4.0	—	nH	Between lead tip and center of die contact	
L _S	Internal Source Inductance	N-P	—	6.0	—			
C _{iss}	Input Capacitance	N-Ch	—	300	—		N-Channel V _{GS} = 0V, V _{DS} = 15V, f = 1.0MHz	③
		P-Ch	—	280	—			
C _{oss}	Output Capacitance	N-Ch	—	260	—		P-Channel	
		P-Ch	—	250	—			
C _{riss}	Reverse Transfer Capacitance	N-Ch	—	62	—		V _{GS} = 0V, V _{DS} = -15V, f = 1.0MHz	
		P-Ch	—	86	—			

Source-Drain Ratings and Characteristics

Parameter	Parameter		Min.	Typ.	Max.	Units	Conditions	
							N-Ch	P-Ch
I _S	Continuous Source Current (Body Diode)		—	—	1.7	A		
			—	—	-1.6			
I _{SM}	Pulsed Source Current (Body Diode) ①		—	—	10			
			—	—	-10			
V _{SD}	Diode Forward Voltage	N-Ch	—	0.90	1.2	V	T _J = 25°C, I _S = 1.6A, V _{GS} = 0V ③	
		P-Ch	—	-0.90	-1.6		T _J = 25°C, I _S = -1.3A, V _{GS} = 0V ③	
t _{rr}	Reverse Recovery Time	N-Ch	—	69	100	ns	N-Channel T _J = 25°C, I _F = 1.25A, di/dt = 100A/μs	③
		P-Ch	—	69	100			
Q _{rr}	Reverse Recovery Charge	N-Ch	—	58	120		P-Channel T _J = 25°C, I _F = -1.25A, di/dt = 100A/μs	
		P-Ch	—	91	180			
t _{on}	Forward Turn-On Time	N-P	Intrinsic turn-on time is negligible (turn-on is dominated by L _S +L _D)					

Notes:

① Repetitive rating; pulse width limited by max. junction temperature. (See fig. 23)

② N-Channel I_{SD} ≤ 2.3A, di/dt ≤ 100A/μs, V_{DD} ≤ V_{(BR)DSS}, T_J ≤ 150°C
P-Channel I_{SD} ≤ -2.3A, di/dt ≤ 50A/μs, V_{DD} ≤ V_{(BR)DSS}, T_J ≤ 150°C

③ Pulse width ≤ 300μs; duty cycle ≤ 2%.

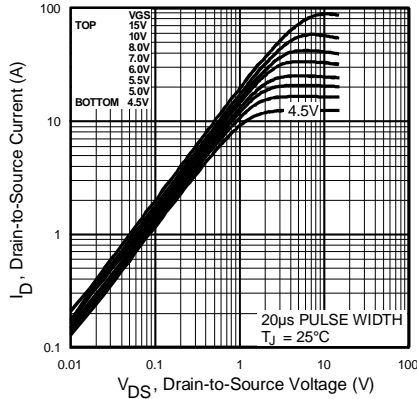

Fig 1. Typical Output Characteristics, $T_J = 25^\circ\text{C}$

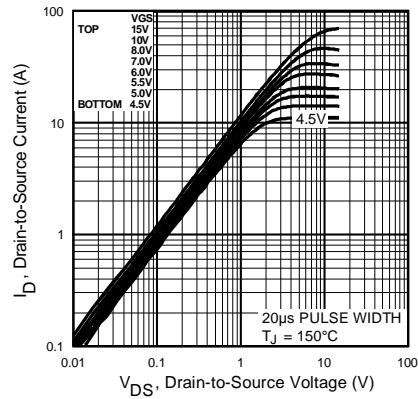

Fig 2. Typical Output Characteristics, $T_J = 150^\circ\text{C}$

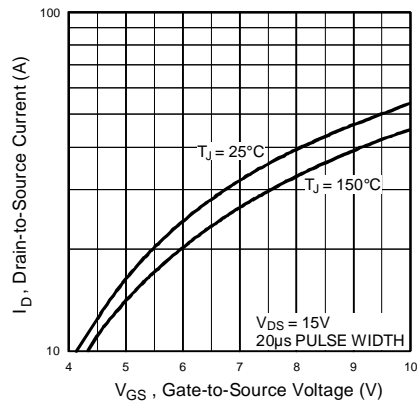

Fig 3. Typical Transfer Characteristics

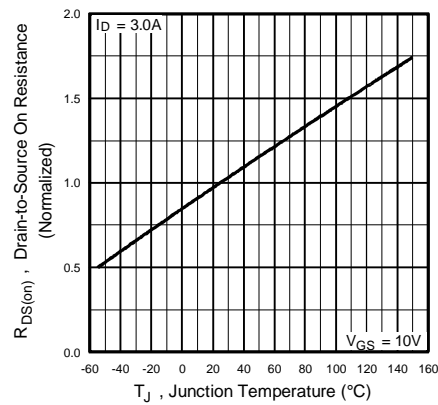

Fig 4. Normalized On-Resistance Vs. Temperature

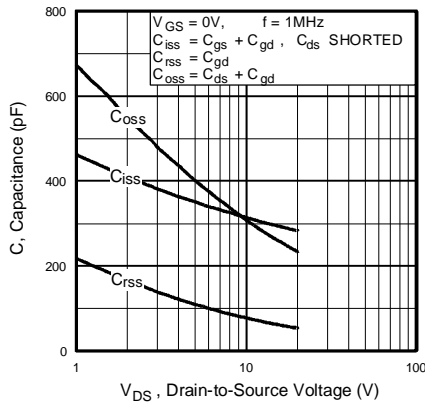

Fig 5. Typical Capacitance Vs. Drain-to-Source Voltage

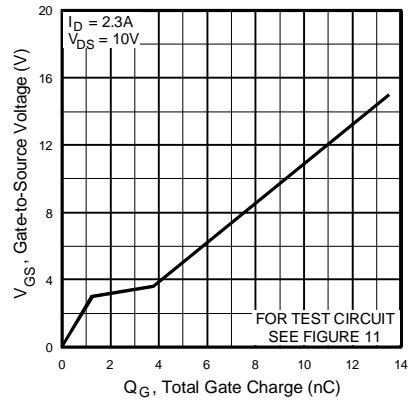

Fig 6. Typical Gate Charge Vs. Gate-to-Source Voltage

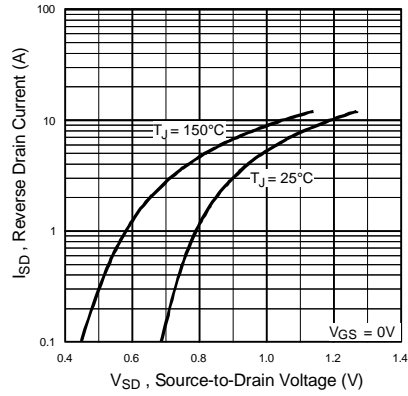

Fig 7. Typical Source-Drain Diode Forward Voltage

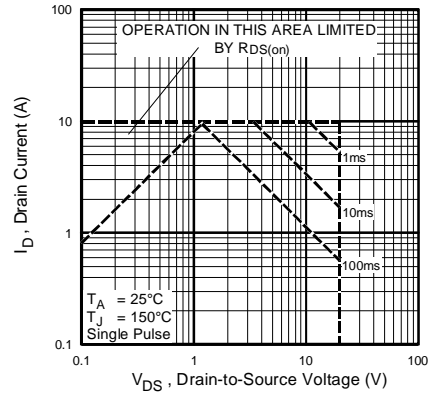

Fig 8. Maximum Safe Operating Area

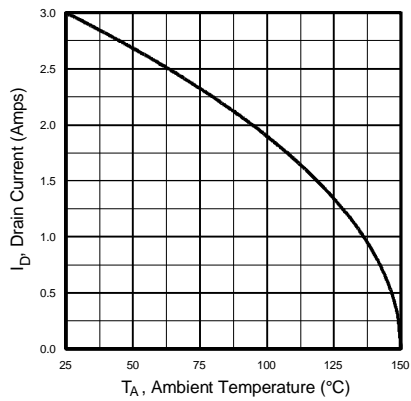

Fig 9. Maximum Drain Current Vs. Ambient Temperature

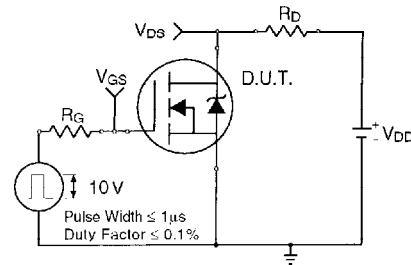

Fig 10a. Switching Time Test Circuit

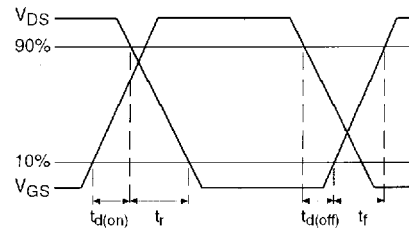

Fig 10b. Switching Time Waveforms

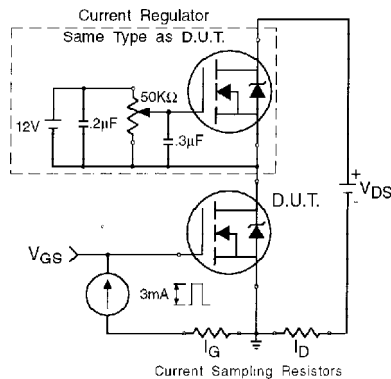

Fig 11a. Gate Charge Test Circuit

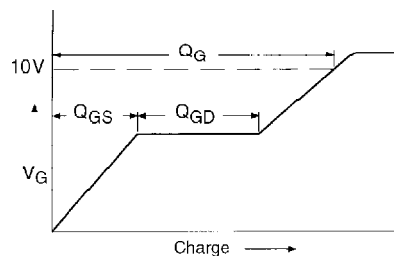

Fig 11b. Basic Gate Charge Waveform

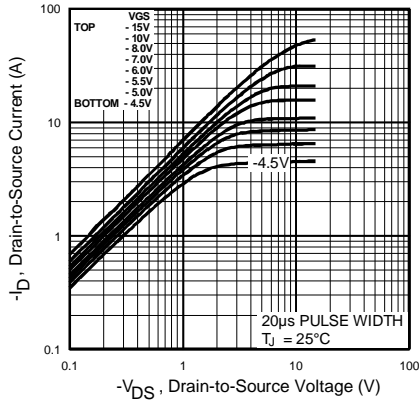

Fig 12. Typical Output Characteristics, $T_J = 25^\circ\text{C}$

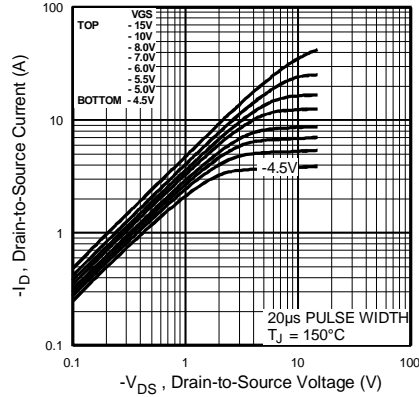

Fig 13. Typical Output Characteristics, $T_J = 150^\circ\text{C}$

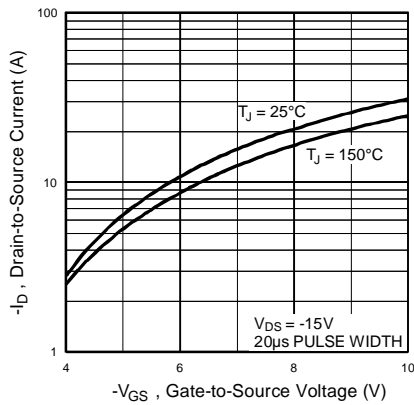

Fig 14. Typical Transfer Characteristics

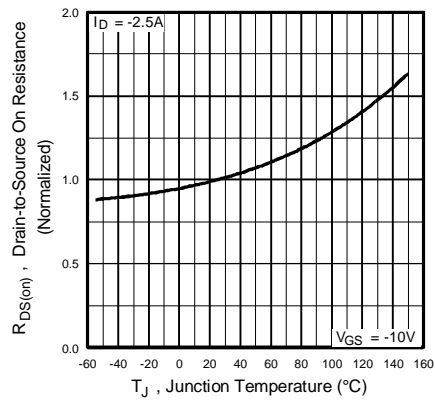

Fig 15. Normalized On-Resistance Vs. Temperature

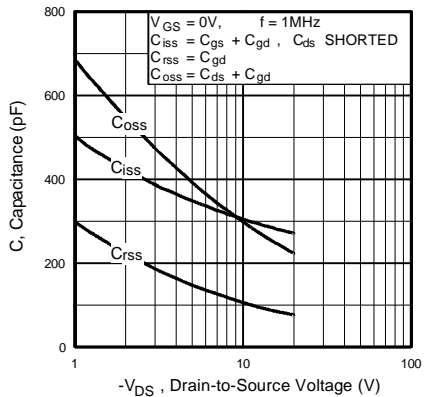

Fig 16. Typical Capacitance Vs. Drain-to-Source Voltage

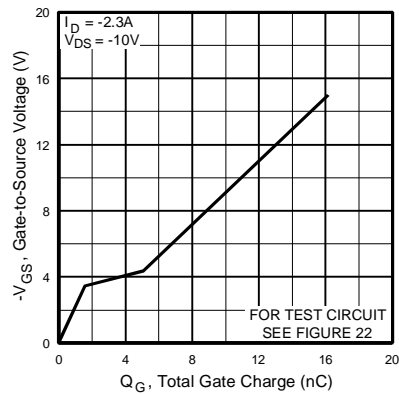

Fig 17. Typical Gate Charge Vs. Gate-to-Source Voltage

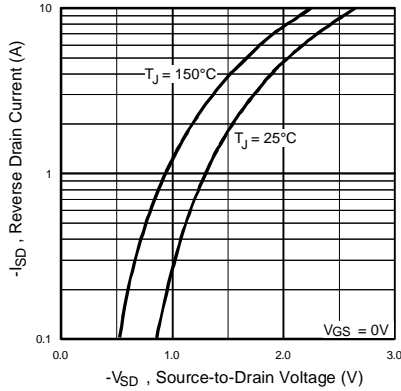

Fig 18. Typical Source-Drain Diode Forward Voltage

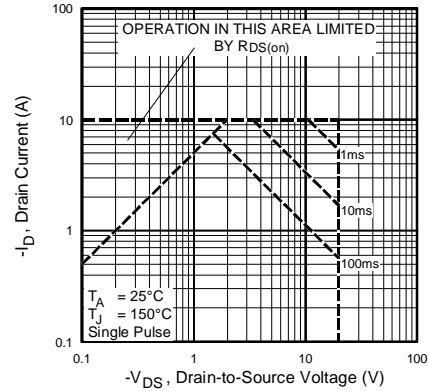

Fig 19. Maximum Safe Operating Area

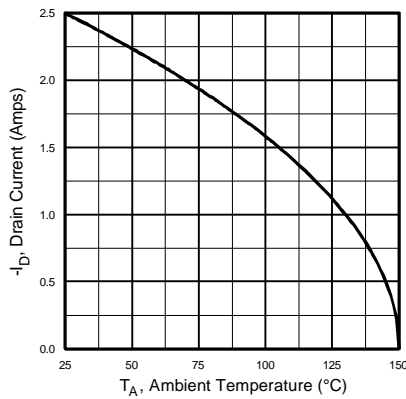

Fig 20. Maximum Drain Current Vs. Ambient Temperature

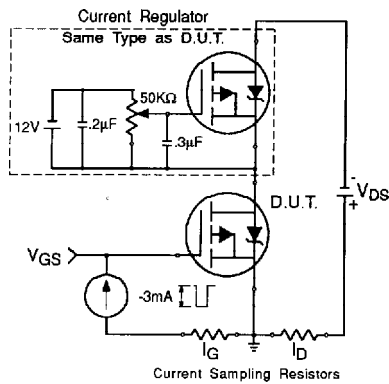

Fig 22a. Gate Charge Test Circuit

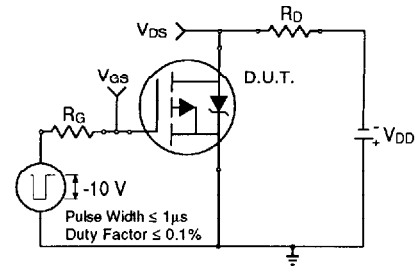

Fig 21a. Switching Time Test Circuit

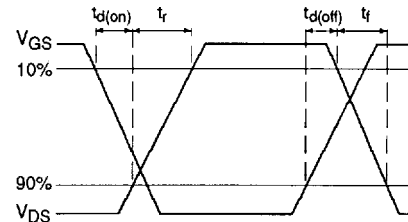

Fig 21b. Switching Time Waveforms

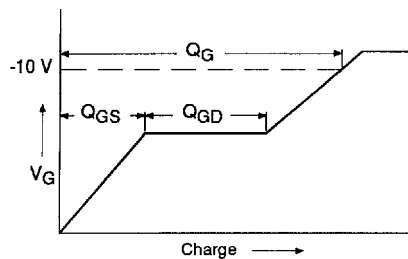

Fig 22b. Basic Gate Charge Waveform

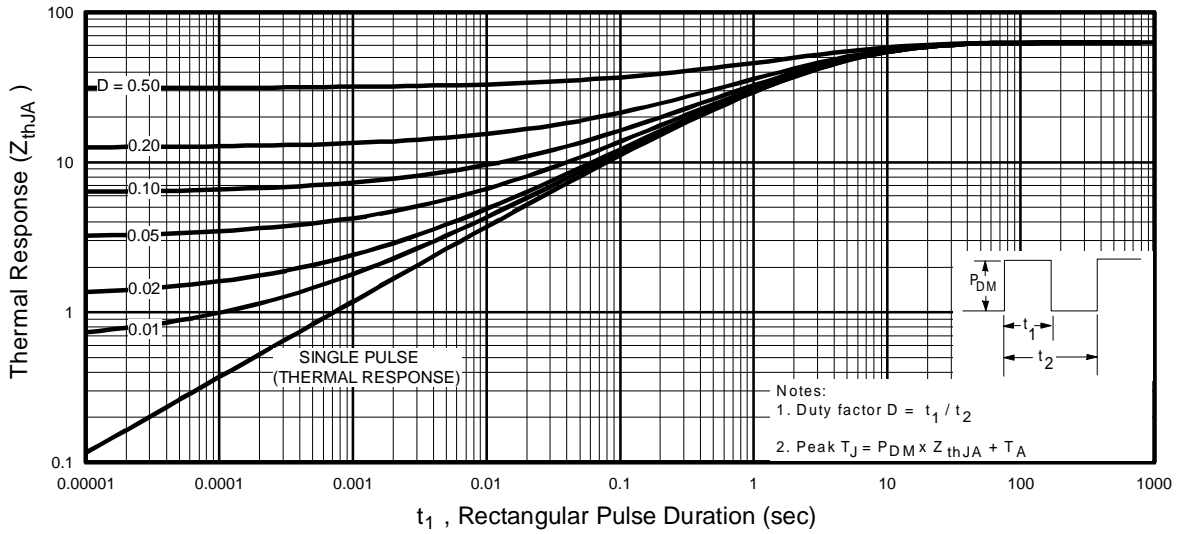

Fig 23. Maximum Effective Transient Thermal Impedance, Junction-to-Ambient

Refer to the Appendix Section for the following:

Appendix A: Figure 24, Peak Diode Recovery dv/dt Test Circuit — See page 329.

Appendix B: Package Outline Mechanical Drawing — See page 332.

Appendix C: Part Marking Information — See page 332.

Appendix D: Tape and Reel Information — See page 336.