

DATA SHEET

AAT3783A: 1 A Linear Li-Ion/Polymer Battery Charger with 28 V Over-Voltage Protection

Applications

- Bluetooth® headsets, headphones, accessories
- Digital still cameras
- Mobile phones
- MP3 players
- Personal data assistants (PDAs)
- Other Li-Ion/polymer battery powered devices

Features

- USB or AC adapter system power charger
- Programmable from 100 mA to 1 A maximum
- 4.0 V ~ 7.5 V input voltage range
 - Over-voltage input protection up to 28 V
- High level of integration with internal:
 - charging device
 - reverse blocking diode
 - current sensing
- Digital thermal regulation
- Charge current programming (ISET)
- Charge termination current programming (TERM)
- Charge timer (CT)
- USBSET pin sets high/low charge level
- Battery temperature sensing (TS)
- TS pin open detection
- Automatic recharge sequencing
- No trickle charge option available
- Full battery charge auto turn off/sleep state/charge termination
- Automatic trickle charge for battery preconditioning
- Battery over-voltage and over-current protection
- Emergency thermal protection
- Power-on reset
- TDFN (16-pin, 3 mm × 4 mm) package (MSL1, 260 °C per JEDEC J-STD-020)

Description

The AAT3783A BatteryManager™ is a single-cell Lithium-Ion (Li-Ion)/Li-Polymer battery charger IC, designed to operate from USB ports, AC adapter inputs, or from a charger adapter up to an input voltage of 6.5 V. For increased safety, the AAT3783A also includes over-voltage input protection (OVP) up to 28 V.

The AAT3783A precisely regulates battery charge voltage and current for 4.2 V Li-Ion/Polymer battery cells through an extremely low R_{DS(ON)} switch. When charged from an adapter or a USB port, the battery charging current can be set by an external resistor up to 1 A. In the case of an over-voltage condition in excess of 6.5 V, a series switch opens to prevent damage to the battery and charging circuitry. With the addition of an external resistor, the OVP trip point can be programmed to a level other than the factory set value of 6.5 V. In the case of an OVP condition a fault flag is activated.

Battery charge state is continuously monitored for fault conditions. In the event of an over-current, battery over-voltage, short-circuit, or over-temperature failure, the device automatically shuts down to protect the charging device, control system, and battery under charge. A status monitor output pin is provided to indicate the battery charge status by directly driving an external LED. An open-drain power-source detection output (ADPP) is provided to report the power supply status.

The AAT3783A is available in a thermally enhanced, space-saving 16-pin, 3 mm × 4 mm TDFN package, and is specified for operation over the –40 °C to +85 °C temperature range.

A typical application circuit is shown in Figure 1. The pin configurations are shown in Figure 2. Signal pin assignments and functional pin descriptions are provided in Table 1.



Skyworks Green™ products are compliant with all applicable legislation and are halogen-free. For additional information, refer to *Skyworks Definition of Green™*, document number SQ04-0074.

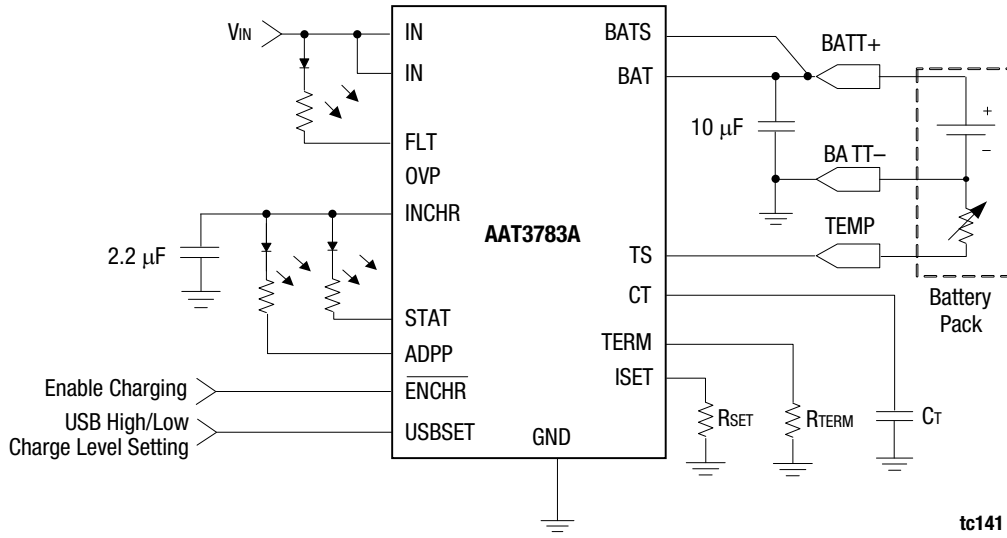

Figure 1. AAT3783A Typical Application Circuit

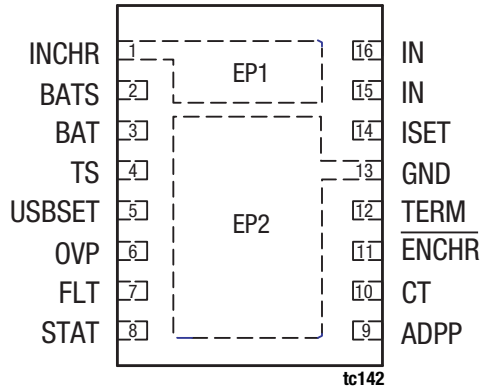

Figure 2. AAT3783A Pinout – 16-Pin, 3 mm × 4 mm TDFN (Top View)

Table 1. AAT3783A Signal Descriptions

Pin	Name	Type	Description
1	INCHR	I/O	Internal connection between the output of the OVP stage and the input of the battery charger. Decouple with 2.2 μ F capacitor.
2	BATS	I	Battery sense pin. Connect directly to the battery's +terminal. If not used, BATS must be connected to BAT.
3	BAT	0	Connect to Lithium-Ion battery.
4	TS	I/O	Battery temperature sense pin.
5	USBSET	I	USB high/low charge level setting. Tie high to set high charge level; charge current is set by RSET. Tie low to set low charge level; charge current becomes 1/5 of the high charge level setting. USBSET is internally pulled down to GND with a 10 M Ω resistor.
6	OVP	I	Over-voltage protection threshold pin. Leave open for the default 6.5 V setting; connect to a resistor to adjust the OVP setting (see Application Information).
7	FLT	0	Over-voltage fault flag, open drain.
8	STAT	0	Charge status pin, open drain.
9	ADPP	0	Input power-good (USB port/adaptor present indicator) pin, open-drain.
10	CT	I	Charge timer programming input pin. Timer disabled when CT pin is connected to GND or the USBSET pin is tied low.
11	ENCHR	I	Active low enable pin (with internal 9 M Ω pull-up to INCHR) for charging circuitry.
12	TERM	I	Charge termination current programming input pin (internal default 10% termination current if TERM is open).
13	GND	I/O	Connect to power ground.
14	ISET	I	Charge current programming input pin.
15, 16	IN	I	Input from USB port/adaptor connector.

Electrical and Mechanical Specifications

The absolute maximum ratings of the AAT3783A are provided in

Table 2, the thermal information is listed in Table 3, and electrical specifications are provided in Table 4.

Table 2. AAT3783A Absolute Maximum Ratings (Note 1)

Parameter	Symbol	Minimum	Typical	Maximum	Units
IN continuous	V _{IN}		30		V
Charger IN continuous	V _{INCHR}	-0.3		7.5	V
Fault flag continuous	V _{FLT}	-0.3		+30	V
BAT, BATS, STAT, ADPP, ENCHR, ISET, TS, USBSET, OVP	V _N	-0.3		V _{INCHR} + 0.3	V
Operating junction temperature range	T _J	-40		150	°C
Maximum soldering temperature (at leads)	T _{LEAD}		300		°C

Note 1: Exposure to maximum rating conditions for extended periods may reduce device reliability. There is no damage to device with only one parameter set at the limit and all other parameters set at or below their nominal value. Exceeding any of the limits listed may result in permanent damage to the device.

Table 3. AAT3783A Thermal Information (Note 1)

Parameter	Symbol	Value	Units
Maximum thermal resistance	θ_{JA}	50	°C/W
Maximum power dissipation	P _D	2	W

Note 1: Mounted on an FR4 board.

CAUTION: Although this device is designed to be as robust as possible, Electrostatic Discharge (ESD) can damage this device. This device must be protected at all times from ESD. Static charges may easily produce potentials of several kilovolts on the human body or equipment, which can discharge without detection. Industry-standard ESD precautions should be used at all times.

DATA SHEET • AAT3783A: 1 A LINEAR LI-ION/POLYMER BATTERY CHARGER WITH 28 V OVER-VOLTAGE PROTECTION

Table 4. AAT3783A Electrical Specifications (1 of 2) (Note 1)
(VIN = 5 V, TA = -40 °C to +85°C, Unless Otherwise Noted, Typical Values are TA = 25 °C)

Parameter	Symbol	Test Condition	Min	Typical	Max	Units
Operation						
Input over-voltage protection range	VIN_MAX				28	V
Normal operating input voltage range	VIN		4.0		7.5	V
Over-Voltage Protection						
Under-voltage lockout threshold	VUVLO	Rising edge		3		V
UVLO hysteresis				60		mV
Operating quiescent current	IQ	VIN = 5 V, IOUT = 0 A, ENCHR = VIN		34	55	μA
Under-voltage lockout threshold	VOVPT	Rising edge, OVP = not connected		6.5		V
Battery Charger						
Under-voltage lockout threshold	VUVLO	Rising edge	3		4	V
UVLO hysteresis				150		mV
Operating current	IOP	Charge current = 100 mA, USBSET = 0 V,, ENCHR = 0 V		0.5	1	mA
Leakage current from BAT pin	IBAT	VBAT = 4 V, USBSET = VIN		0.4	2	μA
Voltage Regulation						
Output charge voltage regulation	VBAT_EOC		4.158	4.20	4.242	V
Output charge voltage tolerance	ΔVCH/VCH			0.5		%
Preconditioning voltage threshold	VMIN	(Option available for no trickle charge)	2.5	2.6	2.7	V
Battery recharge voltage threshold	VRCH			VBAT_EOC - 0.1		V
Current Regulation						
Charge current programmable range	ICC_RANGE		100		1000	mA
Constant-current mode charge current	ICH_CC	VBAT = 3.6 V	-10		10	%
ISET pin voltage at USBSET high setting	VISET_H	USBSET = 5 V		2		V
ISET pin voltage at USBSET low setting	VISET_L	USBSET = 0 V		0.4		V
Charge current set factor: ICH_CC/ISET	KISET	Constant current mode, VBAT = 3.6 V		800		
Term pin voltage	VTERM	RTERM = 13.3 kΩ		0.2		V
Termination current set factor: ICH_TERM/ITERM	KITERM			1000		
Trickle charge current	ICH_TRK		5	10	15	%ICH_CC
Charge termination threshold current	ICH_TERM	TERM pin open	5	10	15	%ICH_CC
		RTERM = 13.3 kΩ, ICH_CC ≥ 800 mA	8	10	12	%
Battery Charging Device						
Total ON resistance (IN to BAT)	RDS(ON)	VIN = 5 V, IOUT = 1 A		550		mΩ

Table 4. AAT3783A Electrical Specifications (2 of 2) (Note 1)
(VIN = 5 V, TA = -40 °C to +85°C, Unless Otherwise Noted, Typical Values are TA = 25 °C)

Parameter	Symbol	Test Condition	Min	Typical	Max	Units
Logic Control						
Input high threshold	VUSBSET(H), VENCHR(H)		1.6			V
Input low threshold	VUSBSET(L), VENCHR(L)				0.4	V
Output low voltage	VSTAT	STAT pin sinks 4 mA			0.4	V
STAT pin current sink capability	ISTAT				8	mA
Output low voltage	VADDP	ADPP pin sinks 4 mA			0.4	V
ADPP pin current sink capability	IADPP				8	mA
Output low voltage	VFLT	FLT pin sinks 1 mA			0.4	V
FLT pin current sink capability	IFLT				5	mA
FLT blanking time	tBLK_FLT	From de-assertion of 0 V	5	10	15	ms
FLT assertion delay time from over-voltage	td_FLT	From assertion of 0 V		1		μs
Over-voltage response time	tRESP_OV	c rise to 7 V from 5 V in 1 ns		1		μs
OVP turn-on delay time	toVPON	Charging current = 500 mA, CINCHR = 1 μF		10		ms
OVP turn-on rise time	toVPR	Charging current = 500 mA, CINCHR = 1 μF		1		ms
OVP turn-off delay time	toVPOFF	Charging current = 500 mA, CINCHR = 1 μF		6		ms
Battery Protection						
Battery over-voltage protection threshold	VBOVP			4.4		V
Battery over-current protection threshold	IBOCP			105		% ICH_CC
Trickle plus constant current mode timeout	TC	CCT = 100 nF, VIN = 5 V		3		Hour
Trickle timeout	TK	CCT = 100nF, VIN = 5 V		25		Minute
Constant voltage mode time out	TV	CCT = 100nF, VIN = 5 V		3		Hour
Current source from TS pin	ITS		69	75	81	μA
TS hot temperature fault	TS1	Threshold	316	331	346	mV
		Hysteresis		25		mV
TS cold temperature fault	TS2	Threshold	2.30	2.39	2.48	V
		Hysteresis		25		mV
Thermal loop entering threshold	TLOOP_IN			115		°C
Thermal loop exiting threshold	TLOOP_OUT			85		°C
Thermal loop regulation	TREG			100		°C
Chip thermal shutdown temperature	TSHDN	Threshold		140		°C
		Hysteresis		15		°C

Note 1: Performance is guaranteed only under the conditions listed in this Table.

Typical Performance Characteristics

Typical performance characteristics of the AAT3783A are illustrated in Figures 3 through 22.

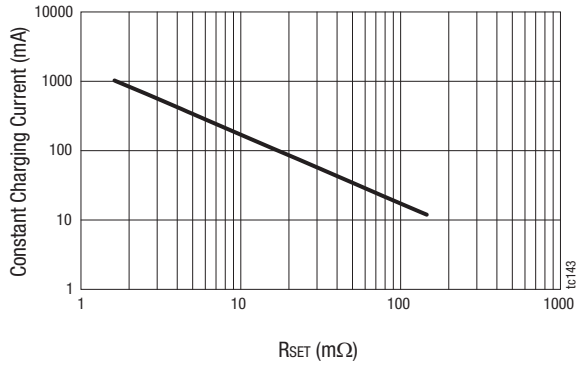

Figure 3. Constant Charging Current vs Set Resistor Values

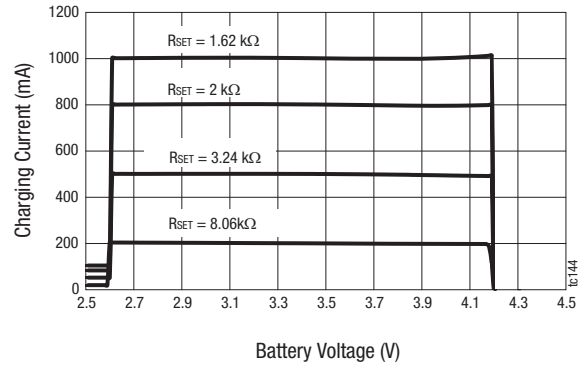

Figure 4. Battery Charging Current vs Battery Voltage

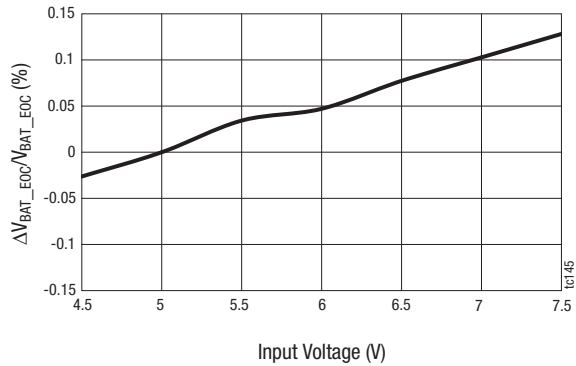

Figure 5. End of Charge Regulation Tolerance vs Input Voltage
(VBAT_EOC = 4.2 V)

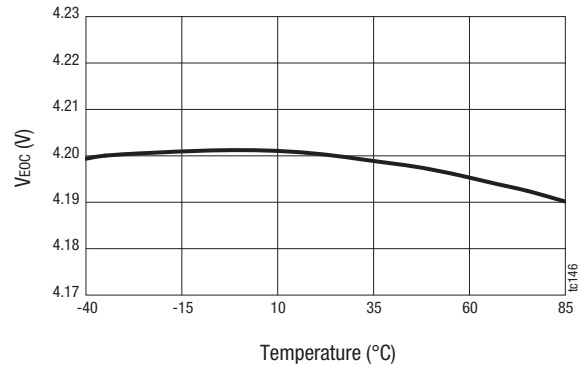

Figure 6. End of Charge Voltage vs Temperature

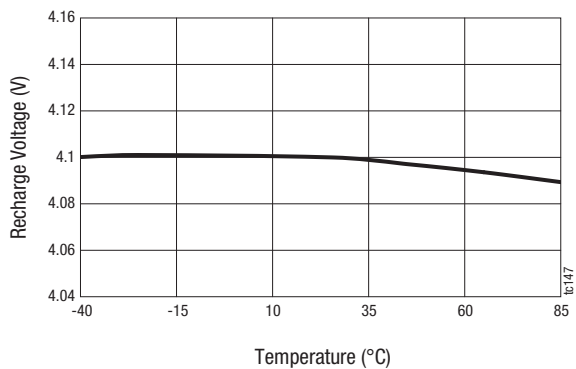

Figure 7. Battery Recharge Voltage Threshold vs Temperature

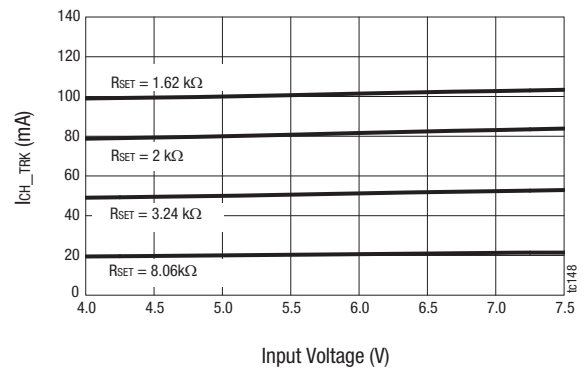

Figure 8. Preconditioning Charge Current vs Input Voltage

Typical Performance Characteristics

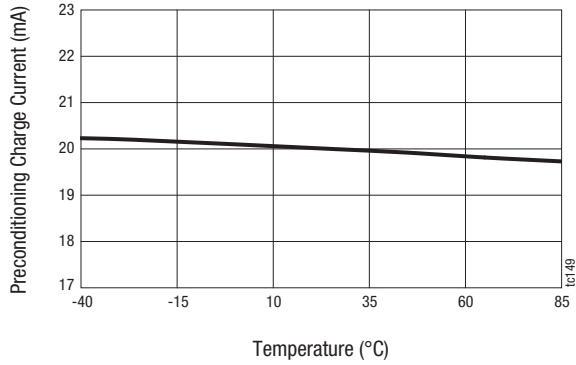

Figure 9. Preconditioning Charge Current vs Temperature
($R_{SET} = 8.06 \text{ k}\Omega$; $I_{CH_CC} = 200 \text{ mA}$)

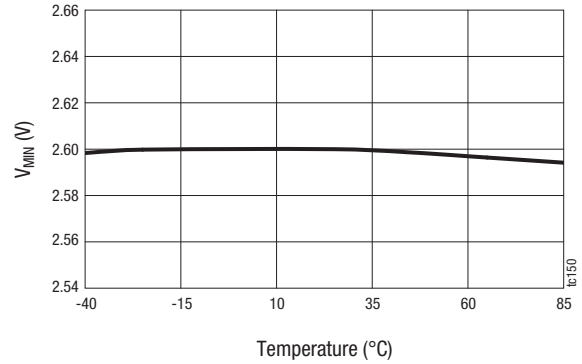

Figure 10. Preconditioning Voltage Threshold vs Temperature

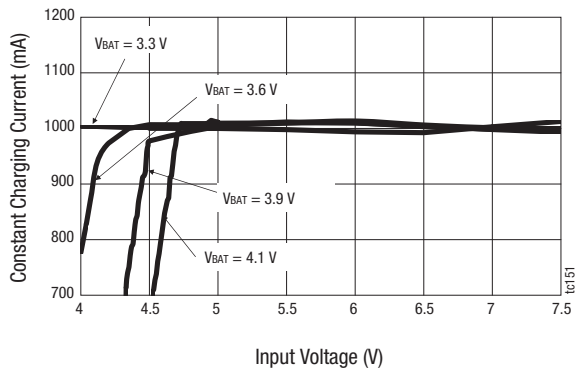

Figure 11. Constant Charging Current vs Input Voltage
($R_{SET} = 1.62 \text{ k}\Omega$)

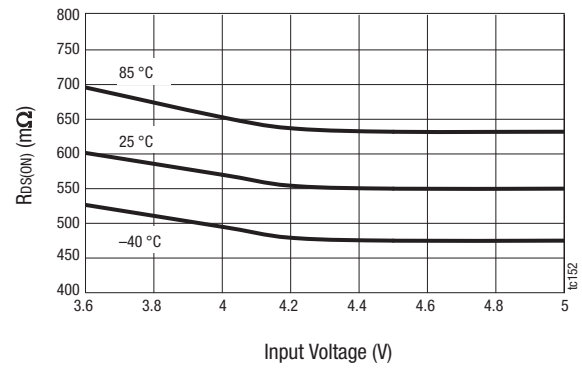

Figure 12. Total Resistance vs Input Voltage
(IN to BAT)

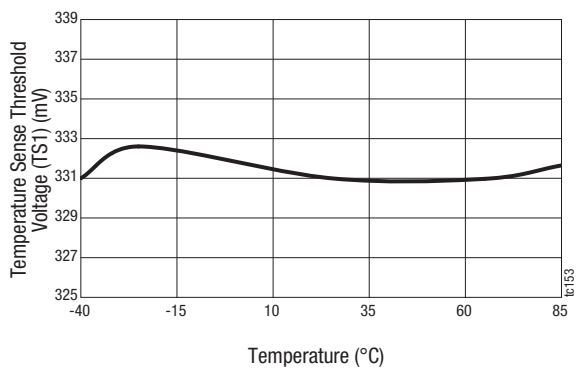

Figure 13. Temperature Sense too Hot Threshold vs Temperature

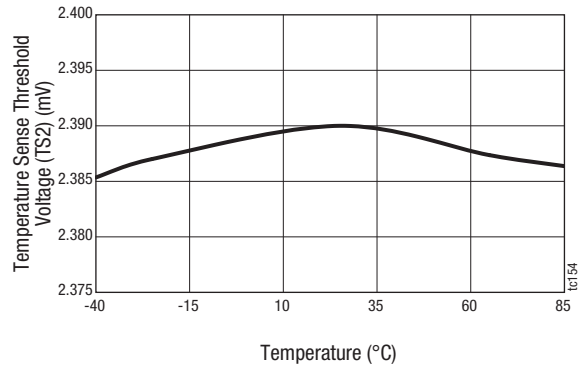

Figure 14. Temperature Sense too Cold Threshold vs Temperature

Typical Performance Characteristics

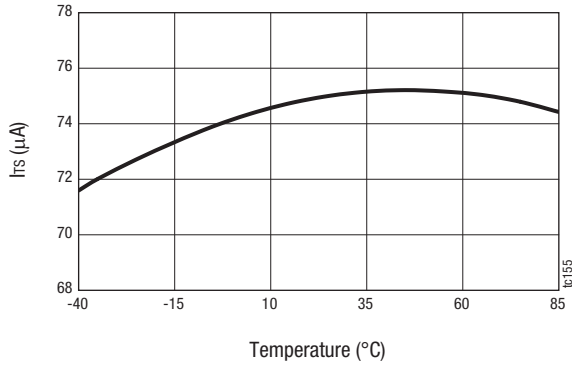

Figure 15. Temperature Sense Output Current vs Temperature

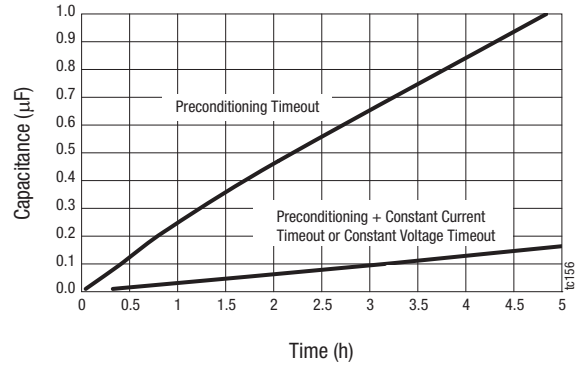

Figure 16. CT Pin Capacitance vs Counter Timeout

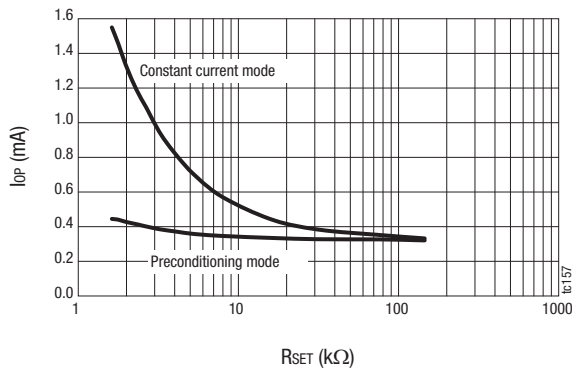

Figure 17. Operating Current vs I_{SET} Resistor

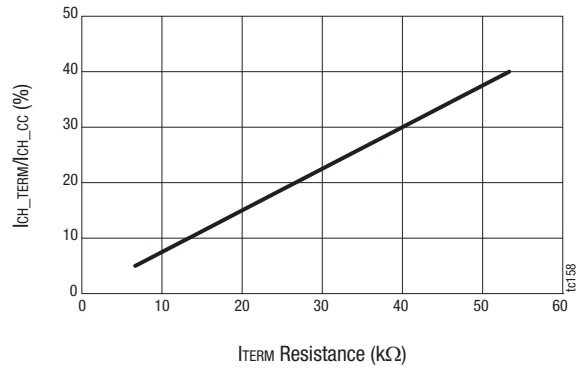

Figure 18. Termination Current to Constant Current Ratio vs Termination Resistance

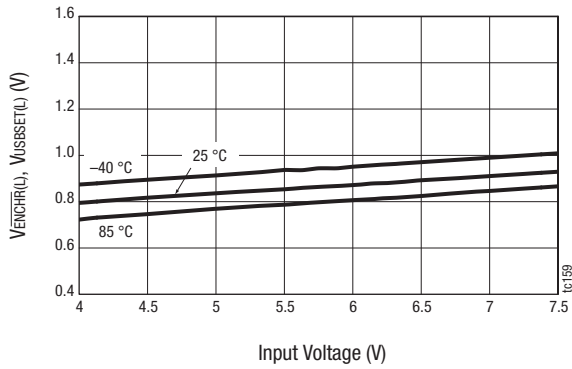

Figure 19. Input Low Threshold vs Input Voltage

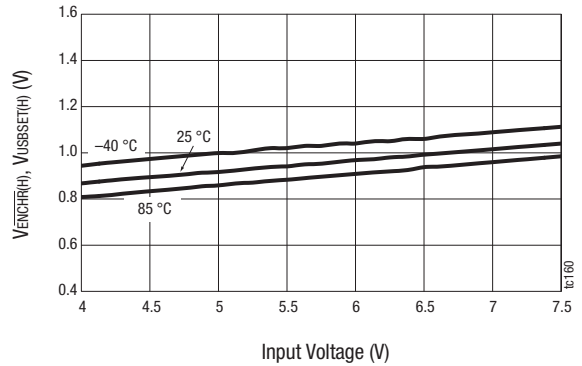

Figure 20. Input High Threshold vs Input Voltage

Typical Performance Characteristics

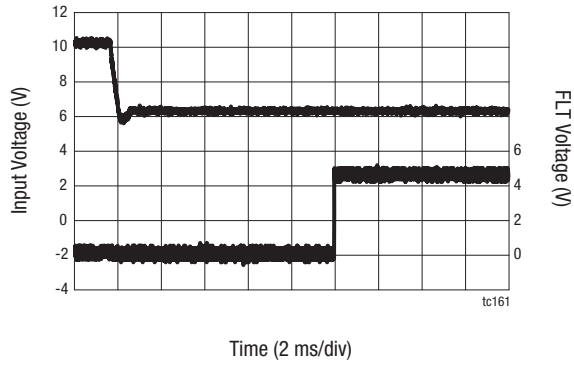

Figure 21. FLT Blanking Time

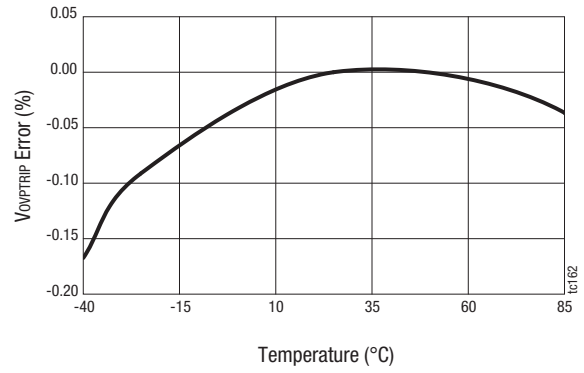

Figure 22. OVP Trip Point vs Temperature

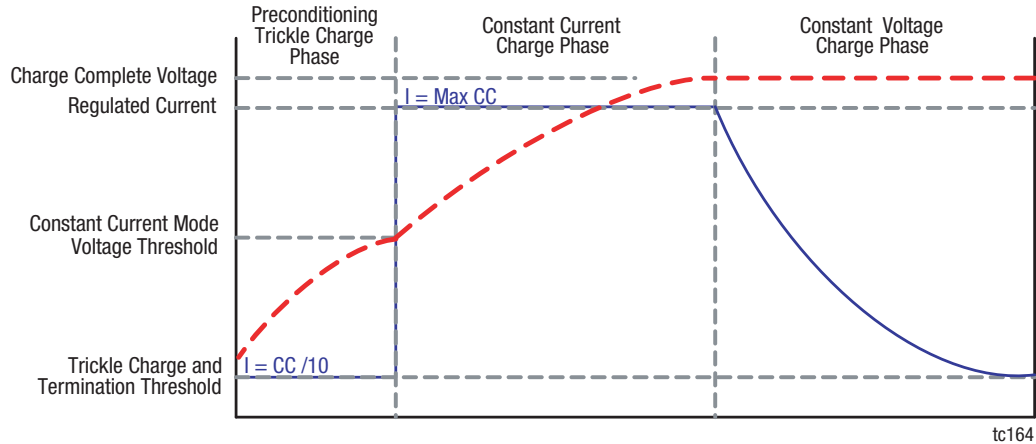

Figure 23. Current vs Voltage Profile during Charging Phases

Constant Current Charging

Battery cell preconditioning continues until the battery voltage reaches the preconditioning voltage threshold, V_{MIN} . At this point, the AAT3783A begins constant current charging. The current level for this mode is programmed using a single resistor from the ISET pin to ground. The programmed current can be set at a minimum 100 mA up to a maximum of 1 A.

The USBSET pin is used for high/low charge level setting. Tie high to set the charge level to high and the charge current to the level set by the ISET pin resistor. Tie low to set the charge level to low and the charge current to 1/5 of the high charge level setting. USBSET is pulled down to GND internally by a 200 k Ω resistor.

Constant Voltage Charging

Constant current charging will continue until such time that the battery voltage reaches the voltage regulation point, V_{BAT_EOC} . When the battery voltage reaches V_{BAT_EOC} , the AAT3783A switches to constant voltage mode. The regulation voltage is factory programmed to a nominal 4.2 V and continues charging until the charge termination current is reached.

Charge Status Output

The AAT3783A provides battery charge status via a status pin. This pin is internally connected to an N-channel open-drain MOSFET, which can be used drive an external LED. The status pin can indicate the conditions in Table 5:

Table 5. LED Status Indicator

Event Description	Status
No battery charging activity	OFF
Battery charging via adapter or USB port	ON
Charging completed	OFF

Thermal Considerations

The actual maximum charging current is a function of the charge adapter input voltage, the battery charge state at the moment of charge, the ambient temperature, and the thermal impedance of the package. The maximum programmable current may not be achievable under all operating parameters.

Over-Voltage Protection

In normal operation, a P-channel MOSFET acts as a slew-rate controlled load switch, connecting and disconnecting the power supply from IN to INCHR. A low resistance MOSFET is used to minimize the voltage drop between the voltage source and the charger and to reduce the power dissipation. When the voltage on the input exceeds the over-voltage trip point (internally set by the factory or externally programmed by a resistor connected to the OVP pin), the device immediately turns off the internal P-channel FET which disconnects the charger from the abnormal input voltage, therefore preventing any damage to the charger. Simultaneously, the fault flag is raised to alert the system.

If an over-voltage condition is applied at the time of the device enable, then the switch remains OFF.

OVP Under-Voltage Lockout (UVLO)

The AAT3783A OVP circuitry has a fixed 3 V under-voltage lockout level (UVLO). When the input voltage is less than the UVLO level, the MOSFET is turned off. 100 mV of hysteresis is included to ensure circuit stability.

Over-Current Protection

The AAT3783A over-current protection provides fault-condition protection that limits the charge current to approximately 1.6 A under all conditions, even if the ISET pin gets shorted to ground.

FLT Blanking Time

The FLT output is an active-low open-drain fault (OV) reporting output. A pull-up resistor should be connected from FLT to the logic I/O voltage of the host system. FLT is asserted immediately when an over-voltage fault occurs (only about a 1 μ s inherited internal circuit delay). A 10 ms blanking is applied to the FLT signal prior to de-assertion.

Enable/Disable

The AAT3783A provides an enable function to turn the charger on and off through the $\overline{\text{ENCHR}}$ pin; $\overline{\text{ENCHR}}$ has an internal pull-up resistor (9 M Ω to INCHR); the OVP switch is permanently enabled regardless of $\overline{\text{ENCHR}}$ enable or disable.

OVP Turn-On Delay Time

On initial power-up, if $V_{\text{IN}} < \text{UVLO}$ or if $V_{\text{ovp}} > 6.5 \text{ V}$, the PMOS is held off. If $\text{UVLO} < V_{\text{IN}}$ and $V_{\text{ovp}} < 6.5 \text{ V}$, the device enters startup after a 10 ms internal delay.

USBSET

USB charge current level can be selected by toggling the USBSET pin. When USBSET = 0, the charge current is set to 1/5 of the programmed charge current level set by ISET. When USBSET = logic high (1.6 V ~ 5 V), the charge current is set to the full programmed charge current level set by ISET.

For example, when charging current is set to 500 mA ($R_{\text{SET}} = 3.24 \text{ k}\Omega$) and USBSET = logic low (0 V), the charge current is 100 A, which is 1/5 of the programmed charge current. When USBSET = logic high (1.6 V ~ 5 V), the charge current becomes 100% (500 mA).

Figure 24 shows the system operation flowchart for the battery charger.

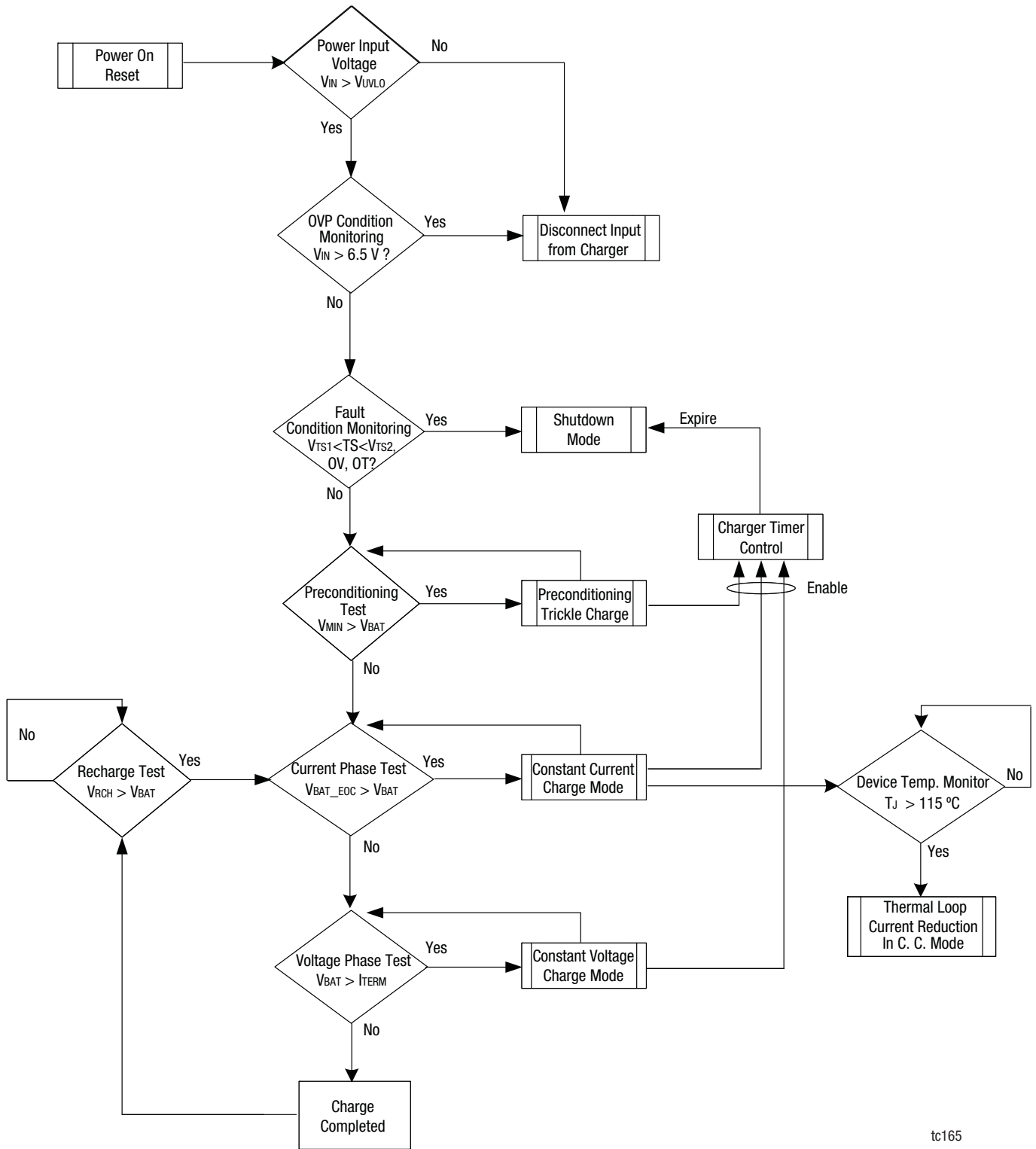

tc165

Figure 24. System Operation Flowchart for the Battery Charger

Application Information

Programming the Over-Voltage Protection Trip Point

The default over-voltage protection trip point of the AAT3783A is set to 6.5 V by the factory. However, the over-voltage protection trip point can be programmed from 3.8 V to 7.5 V by the user with one external resistor, either R5 or R6. The placement of R5 is between IN and OVP. The placement of R6 is between OVP and GND. The OVP trip points can be approximated by the following formulas:

If using R5 (OVP to IN):

$$V_{OVP_TRIPPOINT} = \frac{1.1 \times \{1.426 \parallel [(R5 + 1.498) + 0.29]\}}{0.29}$$

If using R6 (OVP to GND):

$$V_{OVP_TRIPPOINT} = \frac{1.1 \times \{1.426 + [0.29 \parallel (R6 + 1.498)]\}}{(0.29 \parallel R6 + 1.498)}$$

Here, voltage in V, resistance in MΩ.

Table 6 summarizes resistor values for various over-voltage protection trip points. Use 1% tolerance metal film resistors for programming the desired OVP trip point.

Table 6. Programming OVP Trip Point for AAT3783A with One Resistor

R6 (MΩ)	R5 (MΩ)	VOVP_TRIPPOINT (V)
short	open	7.5
0.499	open	7.25
1.3	open	7.0
3.01	open	6.75
open	open	6.5
open	4.99	5.5
open	2.49	5.0
open	1.0	4.5
open	short	3.87

Battery Connection and Battery Voltage Sensing

Battery Connection (BAT)

A single cell Li-Ion/Polymer battery should be connected between the BAT pin and ground.

Battery Voltage Sensing (BATS)

The BATS pin is provided to employ an accurate voltage sensing capability to measure the positive terminal voltage at the battery cell being charged. This function reduces measured battery cell voltage error between the battery terminal and the charge control IC. The AAT3783A charge control circuit will base charging mode states upon the voltage sensed at the BATS pin. The BATS pin must be connected to the battery terminal for correct operation. If the battery voltage sense function is not

needed, the BATS pin should be terminated directly to the BAT pin. If there is concern of the battery sense function inadvertently becoming an open circuit, the BATS pin may be terminated to the BAT pin using a 10 kΩ resistor. Under normal operation, the connection to the battery terminal is close to 0 Ω; if the BATS connection becomes an open circuit, the 10 kΩ resistor provides feedback to the BATS pin from the BAT connection with a voltage sensing accuracy loss of 1 mV or less.

Constant Charge Current

The constant current mode charge level is user programmed with a set resistor placed between the ISET pin and ground. The accuracy of the constant charge current, as well as the preconditioning trickle charge current, is dominated by the tolerance of the set resistor used (see Figure 25). For this reason, a 1% tolerance metal film resistor is recommended for the set resistor function. The constant charge current levels from 100 mA to 1 A may be set by selecting the appropriate resistor value from Table 7.

Table 7. RSET Values

Constant Charging Current (mA)	Set Resistor Value (kΩ)
10	162
20	80.6
50	32.4
100	16
200	8.06
300	5.36
400	4.02
500	3.24
600	2.67
700	2.26
800	2
900	1.78
1000	1.62

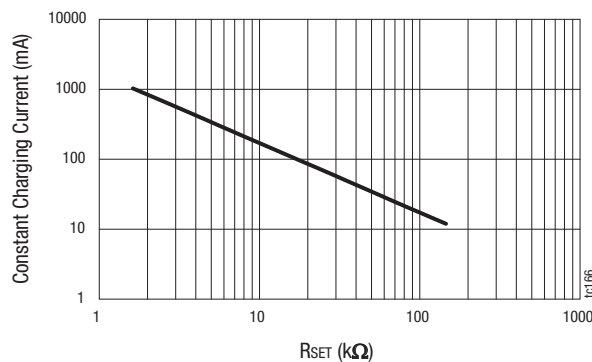

Figure 25. Constant Charging Current vs Set Resistor Values

Charge Termination Current

The charge termination current I_{CH_TERM} can be programmed by connecting a resistor from TERM to GND:

$$I_{CH_TERM} = \frac{15\mu A \times R_{TERM}}{2V} \times I_{CH_CC}$$

Where:

I_{CH_TERM} = charge termination current level

I_{CH_CC} = programmed fast charge constant current level

R_{TERM} = TERM resistor value

If the TERM pin is left open, the termination current is set to 10% of the constant charging current as the default value.

When the charge current drops to the defaulted 10% of the programmed charge current level or programmed terminated current in the constant voltage mode, the device terminates charging and goes into a sleep state. If the programmed termination current exceeds 1/5 of the fast charge level, and the low charge level is selected (USBSET = low), charging terminates immediately upon reaching constant voltage mode. The charger remains in this sleep state until the battery voltage falls to a level below the battery recharge voltage threshold (VRCH).

Consuming very low current in the sleep state, the AAT3783A minimizes battery drain when it is not charging. This feature is particularly useful in applications where the input supply level may fall below the battery charge or under-voltage lockout level. In such cases where the AAT3783A input voltage drops, the device enters sleep state and automatically resumes charging once the input supply has recovered from the fault condition.

Protection Circuitry

Programmable Watchdog Timer

The AAT3783A contains a watchdog timing circuit to shut down charging functions in the event of a defective battery cell not accepting a charge over a preset period of time. Typically, a 0.1 μ F ceramic capacitor is connected between the CT pin and ground. When a 0.1 μ F ceramic capacitor is used, the device will time out a shutdown condition if the trickle charge mode exceeds 25 minutes and a combined trickle charge plus constant current mode of 3 hours. When the device transitions to the constant voltage mode, the timing counter is reset and will time out after an additional 3 hours if the charge current does not drop to the charge termination level, as shown in Table 8.

Table 8. Summary for a 0.1 μ F Ceramic Capacitor Used for the Timing Capacitor

Mode	Time
Trickle charge (TC) time out	25 minutes
Trickle charge (TC) + constant current (CC) mode time out	3 hours
Constant voltage (CV) mode time out	3 hours

The CT pin is driven by a constant current source and provides a linear response to increases in the timing capacitor value. Thus, if the timing capacitor were to be doubled from the nominal 0.1 μ F value, the timeout periods would be doubled. If the programmable watchdog timer function is not needed, it can be disabled by terminating the CT pin or the USBSET pin to ground. The CT pin should not be left floating or unterminated, as this causes errors in the internal timing control circuit.

The constant current provided to charge the timing capacitor is very small, and this pin is susceptible to noise and changes in capacitance value. Therefore, the timing capacitor should be physically located on the printed circuit board layout as close as possible to the CT pin. Since the accuracy of the internal timer is dominated by the capacitance value, a 10% tolerance or better ceramic capacitor is recommended. Ceramic capacitor materials, such as X7R and X5R types, are good choices for this application.

Battery Over-Voltage Protection

An over-voltage event is defined as a condition where the voltage on the BAT pin exceeds the maximum battery charge voltage and is set by the over-voltage protection threshold (VBOVP). If an over-voltage condition occurs, the AAT3783A charge control shuts down the device until the voltage on the BAT pin drops below VOVp.

The AAT3783A resumes normal charging operation after the over-voltage condition is removed.

Battery Temperature Monitoring

In the event of a battery over-temperature condition, the charge control turns off the internal pass device. After the system recovers from a temperature fault, the device resumes charging operation. The AAT3783A checks battery temperature before starting the charge cycle, as well as during all stages of charging. This is accomplished by monitoring the voltage at the TS pin. This system is intended for use with negative temperature coefficient thermistors (NTC) which are typically integrated into the battery package. Most of the commonly used NTC thermistors in battery packs are approximately 10 k Ω at room temperature (25 $^{\circ}$ C). The TS pin has been specifically designed to source 75 μ A of current to the thermistor. The voltage on the TS pin resulting from the resistive load should stay within a window of 331 mV to 2.39 V. If the battery becomes too hot during charging due to an internal fault or

excessive constant charge current, the thermistor will heat up and reduce in value, pulling the TS pin voltage lower than the TS1 threshold, and the AAT3783A stops charging until the condition is removed, when charging is resumed. If the use of the TS pin function is not required by the system, it should be terminated to ground using a 10 kΩ resistor. Alternatively, on the AAT3783A, the TS pin may be left open.

Over-Temperature Shutdown

The AAT3783A has a thermal protection control circuit, which shuts down charging functions should the internal die temperature exceed the preset thermal limit threshold. Once the internal die temperature falls below the thermal limit, normal operation resumes the previous charging state.

Digital Thermal Loop Control

Due to the integrated nature of the linear charging control pass device for the adapter mode, a special thermal loop control system has been employed to maximize charging current under all operation conditions. The thermal management system measures the internal circuit die temperature and reduces the fast charge current when the device exceeds a preset internal temperature control threshold. Once the thermal loop control becomes active, the fast charge current is initially reduced by a factor of 0.44.

The initial thermal loop current can be estimated by the following equation:

$$I_{TLOOP} = I_{CH_CC} \times 0.44$$

The thermal loop control re-evaluates the circuit die temperature every three seconds and adjusts the fast charge current back up in small steps to the full fast charge current level or until an equilibrium current is discovered and maximized for the given ambient temperature condition. The thermal loop controls the system charge level; therefore, the AAT3783A always provides the highest level of constant current in the fast charge mode possible for any given ambient temperature condition.

Thermal Considerations and High Output Current Applications

The AAT3783A delivers a continuous charging current. The limiting characteristic for maximum safe operating charging current is its package power dissipation. Many considerations should be taken into account when designing the printed circuit board layout, as well as the placement of the IC package in proximity to other heat generating devices in a given application design. The ambient temperature around the IC will also have an effect on the thermal limits of a battery charging application.

The maximum limits that can be expected for a given ambient condition can be estimated by the following discussion. First,

the maximum power dissipation for a given situation should be calculated:

$$P_{D(MAX)} = \frac{T_{J(MAX)} - T_A}{\theta_{JA}}$$

Where:

PD(MAX) = maximum power dissipation (W)

θJA = package thermal resistance (°C/W)

TJ = thermal loop entering threshold (°C) [115 °C]

TA = ambient temperature (°C)

Figure 26 shows the relationship of maximum power dissipation and ambient temperature of the AAT3783A.

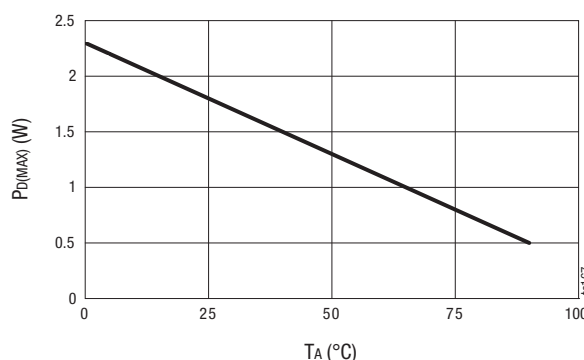

Figure 26. Maximum Power Dissipation Before Entering Digital Thermal Loop

Next, the power dissipation can be calculated by the following equation:

$$P_D = (V_{IN} - V_{BAT}) \times I_{CH} + (V_{IN} \times I_{OP})$$

Where:

PD = total power dissipation by the device

VIN = input voltage

VBAT = battery voltage as seen at the BAT pin

ICH = constant charge current programmed for the application

IOP = quiescent current consumed by the charger ic for normal operation [0.4 mA]

By substitution, we can derive the maximum charge current before reaching the thermal limit condition (thermal loop). The maximum charge current is the key factor when designing battery charger applications.

$$I_{CH(MAX)} = \frac{P_{D(MAX)} - V_{IN} \times I_{OP}}{V_{IN} - V_{BAT}}$$

$$I_{CH(MAX)} = \frac{\frac{T_{J(MAX)} - T_A}{\theta_{JA}} - V_{IN} \times I_{OP}}{V_{IN} - V_{BAT}}$$

In general, the worst condition is the greatest voltage drop across the charger IC, when battery voltage is charged up to the preconditioning voltage threshold and before entering thermal loop regulation. Figure 27 shows the maximum charge current in different ambient temperatures.

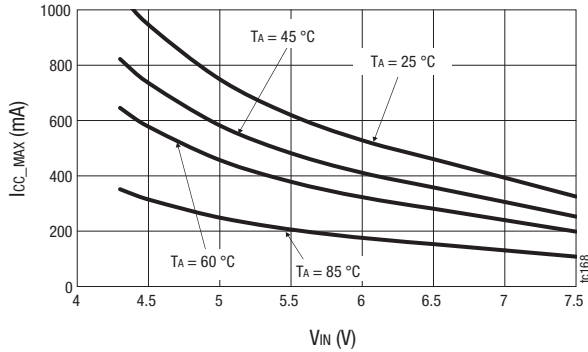

Figure 27. Maximum Charging Current Before the Digital Thermal Loop Becomes Active

Input Capacitor

A 1 μ F or larger capacitor is typically recommended for C_{IN}. C_{IN} should be located as close to the device VIN pin as practically possible. Ceramic, tantalum, or aluminum electrolytic capacitors may be selected for C_{IN}. There is no specific capacitor equivalent series resistance (ESR) requirement for C_{IN}. However, for higher current operation, ceramic capacitors are recommended for C_{IN} due to their inherent capability over tantalum capacitors to withstand input current surges from low impedance sources such as batteries in portable devices.

Typically, 50 V rated capacitors are required for most of the application to prevent any surge voltage. Ceramic capacitors as small as 1210 are available which can meet these requirements. Other voltage rating capacitors can also be used for the known input voltage application.

Charger Input Capacitor

A 2.2 μ F decoupling capacitor is recommended to be placed between INCHR and GND.

Charger Output Capacitor

The AAT3783A only requires a 1 μ F ceramic capacitor on the BAT pin to maintain circuit stability. This value should be

increased to 10 μ F or more if the battery connection is made any distance from the charger output. If the AAT3783A is used in applications where the battery can be removed from the charger, such as with desktop charging cradles, an output capacitor greater than 10 μ F may be required to prevent the device from cycling on and off when no battery is present.

Printed Circuit Board Layout Recommendations

For proper thermal management and to take advantage of the low R_{DS(ON)} of the AAT3783A, follow these circuit board layout rules:

1. VIN and VOUT should be routed using wider than normal traces, and GND should be connected to a ground plane.
2. To maximize package thermal dissipation and power handling capacity of the AAT3783A TDFN package, solder the exposed paddle of the IC onto the thermal landing of the PCB, where the thermal landing is connected to the ground plane.
3. This AAT3783A has two exposed paddles (EP1 and EP2). EP1 is connected to INCHR (pin 1) and EP2 is connected to GND (pin 13). DO NOT make one whole thermal landing!
4. If heat is still an issue, multi-layer boards with dedicated ground planes are recommended.
5. Also, adding more thermal vias on the thermal landing would help the heat being transferred to the PCB effectively.

Evaluation Board Description

The AAT3783A Evaluation Board is used to test the performance of the AAT3783A. An Evaluation Board schematic diagram is provided in Figure 28. Layer details for the Evaluation Board are shown in Figure 29. The Evaluation Board has additional components for easy evaluation; the actual bill of materials required for the system is shown in Table 9.

Package Information

Package dimensions for the 16-pin TDFN package are shown in Figure 30. Tape & reel dimensions are shown in Figure 31.

DATA SHEET • AAT3783A: 1 A LINEAR LI-ION/POLYMER BATTERY CHARGER WITH 28 V OVER-VOLTAGE PROTECTION

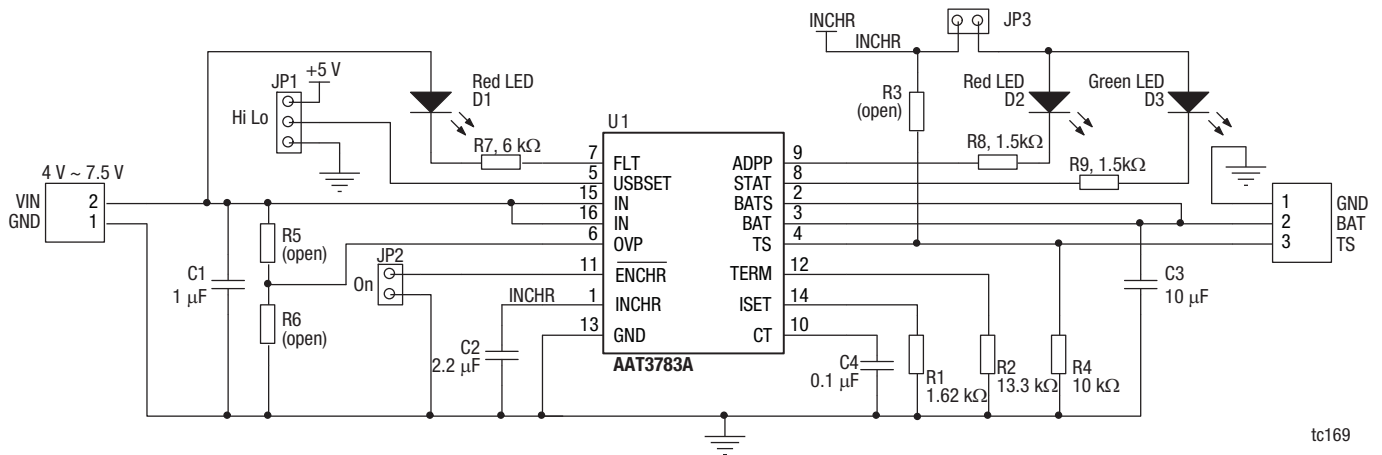

Figure 28. AAT3783A Evaluation Board Schematic

Table 9. AAT3783A Evaluation Board Bill of Materials

Component	Part number	Description	Manufacturer
U1	AAT3783AIRN-T1	1 A Linear Li-Ion/Polymer Battery Charger with 28 V Over-Voltage Protection; TDFN Package	Skyworks
R1	Chip Resistor	1.62 kΩ, 1%, 1/4 W; 0603	Vishay
R2	Chip Resistor	13.3 kΩ, 1%, 1/4 W; 0603	Vishay
R4	Chip Resistor	10 kΩ, 5%, 1/4 W; 0603	Vishay
R7	Chip Resistor	6 kΩ, 5%, 1/4 W; 0603	Vishay
R8, R9	Chip Resistor	1.5 kΩ, 5%, 1/4 W; 0402	Vishay
C1	GRM31MR71H105KA88 (GRM31CR71H225KA88L) (GRM32ER71H475KA88L)	CER 1 µF, 50 V, 10% X7R 1206 (CER 2.2 µF, 50 V, 10% X7R 1206) (CER 4.7 µF, 50 V, 10% X7R 1210)	Murata
C2	GRM188R61A225KE34	CER 2.2 µF, 10 V, 10% X5R 0805	Murata
C3	GRM21BR71A106KE51L	CER 10 µF, 10 V, 10% X7R 0805	Murata
C4	GRM188R71E104KA01	CER 0.1 µF, 25 V, 10% X7R 0603	Murata
JP1, JP2, JP3	PRPN401PAEN	Connector, header, 2 mm zip	Sullins Electronics
D1, D2	LTST-C190CKT	Red LED; 0603	Lite-On Inc.
D3	LTST-G190CKT	Green LED; 0603	Lite-On Inc.

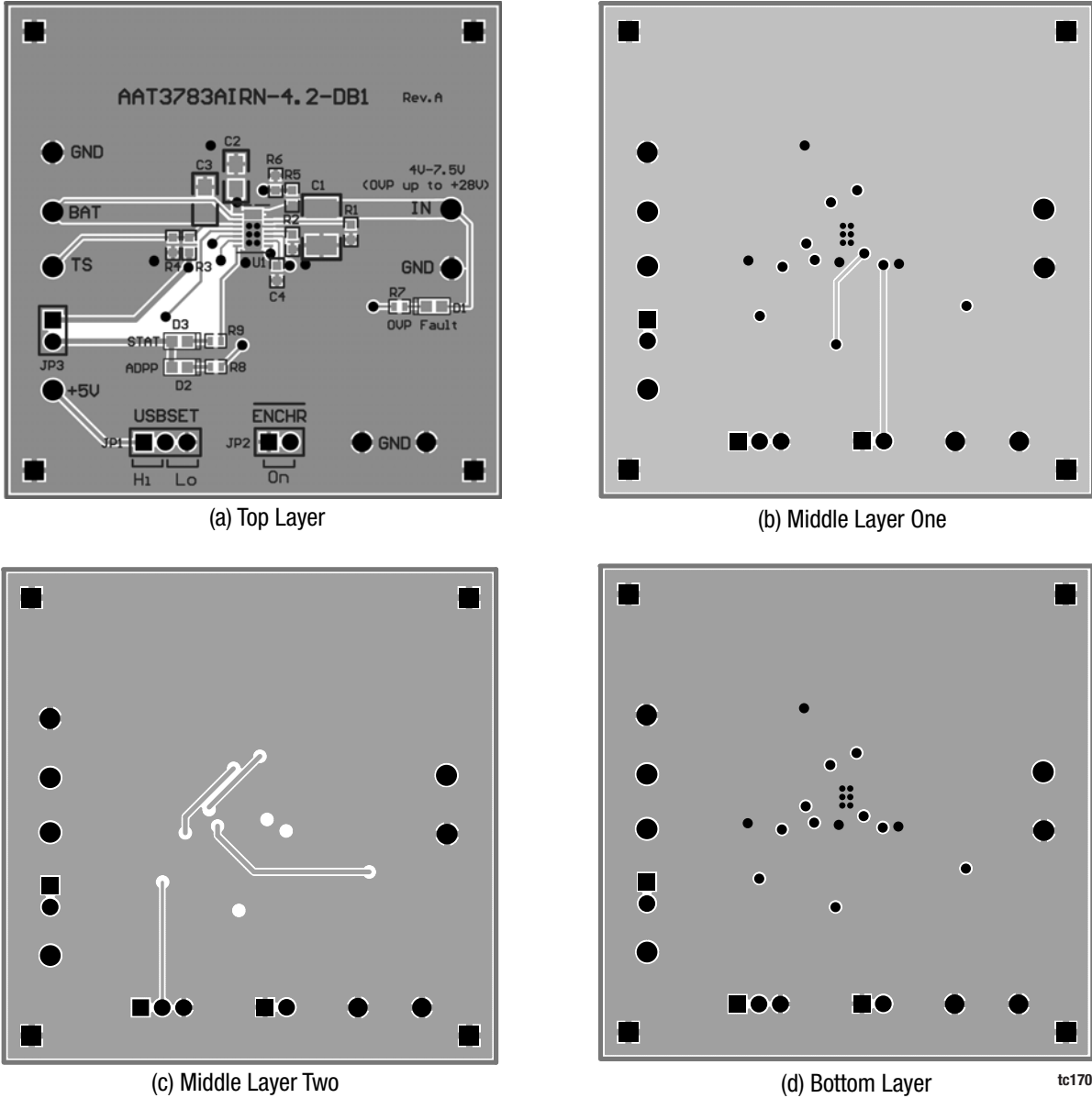

Figure 29. AAT3783A Evaluation Board Layer Details

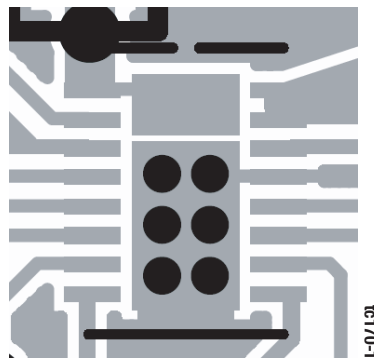
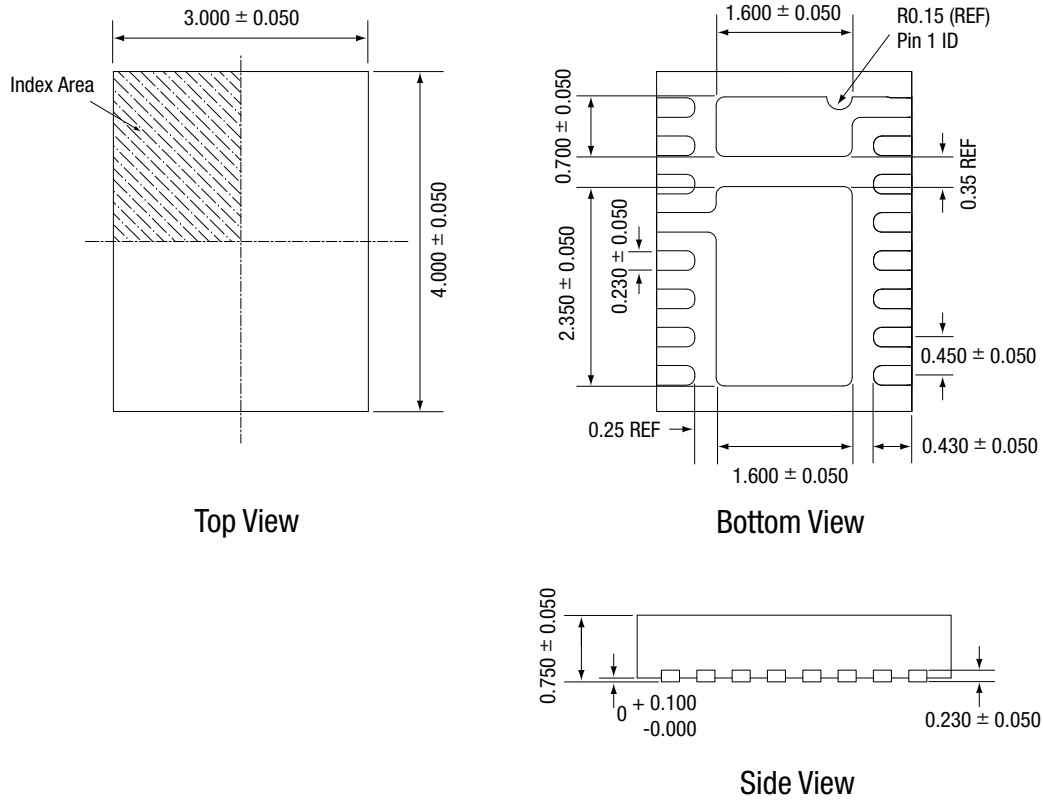

Figure 30. Magnified View of Exposed Paddles on AAT3783A Evaluation Board Top Layer



All measurements are in millimeters.

tc171

Figure 30. AAT3783A 16-pin TDFN Package Dimensions

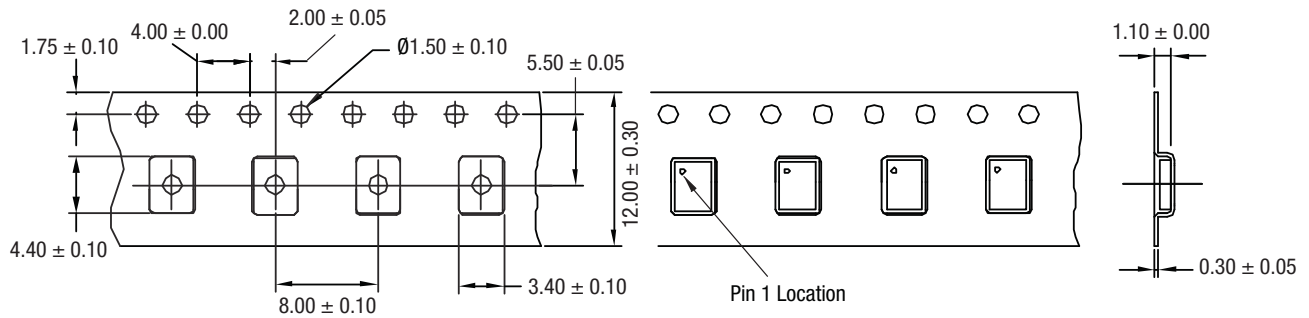

All dimensions are in millimeters

t0280

Figure 31. AAT3783A TDFN34-16 Tape and Reel Dimensions

Ordering Information

Model Name	Part Marking (Note 1)	Manufacturing Part Number (Note 2)	Evaluation Board Part Number
AAT3783A: 1 A linear li-ion/polymer battery charger with 28 V over-voltage protection	5EXYY	AAT3783AIRN-4.2	AAT3783AIRN-4.2-EVB

Note 1: XYY = assembly and date code.

Note 2: Sample stock is generally held on part numbers listed in **BOLD**.

Copyright © 2012-2014 Skyworks Solutions, Inc. All Rights Reserved.

Information in this document is provided in connection with Skyworks Solutions, Inc. ("Skyworks") products or services. These materials, including the information contained herein, are provided by Skyworks as a service to its customers and may be used for informational purposes only by the customer. Skyworks assumes no responsibility for errors or omissions in these materials or the information contained herein. Skyworks may change its documentation, products, services, specifications or product descriptions at any time, without notice. Skyworks makes no commitment to update the materials or information and shall have no responsibility whatsoever for conflicts, incompatibilities, or other difficulties arising from any future changes.

No license, whether express, implied, by estoppel or otherwise, is granted to any intellectual property rights by this document. Skyworks assumes no liability for any materials, products or information provided hereunder, including the sale, distribution, reproduction or use of Skyworks products, information or materials, except as may be provided in Skyworks Terms and Conditions of Sale.

THE MATERIALS, PRODUCTS AND INFORMATION ARE PROVIDED "AS IS" WITHOUT WARRANTY OF ANY KIND, WHETHER EXPRESS, IMPLIED, STATUTORY, OR OTHERWISE, INCLUDING FITNESS FOR A PARTICULAR PURPOSE OR USE, MERCHANTABILITY, PERFORMANCE, QUALITY OR NON-INFRINGEMENT OF ANY INTELLECTUAL PROPERTY RIGHT; ALL SUCH WARRANTIES ARE HEREBY EXPRESSLY DISCLAIMED. SKYWORKS DOES NOT WARRANT THE ACCURACY OR COMPLETENESS OF THE INFORMATION, TEXT, GRAPHICS OR OTHER ITEMS CONTAINED WITHIN THESE MATERIALS. SKYWORKS SHALL NOT BE LIABLE FOR ANY DAMAGES, INCLUDING BUT NOT LIMITED TO ANY SPECIAL, INDIRECT, INCIDENTAL, STATUTORY, OR CONSEQUENTIAL DAMAGES, INCLUDING WITHOUT LIMITATION, LOST REVENUES OR LOST PROFITS THAT MAY RESULT FROM THE USE OF THE MATERIALS OR INFORMATION, WHETHER OR NOT THE RECIPIENT OF MATERIALS HAS BEEN ADVISED OF THE POSSIBILITY OF SUCH DAMAGE.

Skyworks products are not intended for use in medical, lifesaving or life-sustaining applications, or other equipment in which the failure of the Skyworks products could lead to personal injury, death, physical or environmental damage. Skyworks customers using or selling Skyworks products for use in such applications do so at their own risk and agree to fully indemnify Skyworks for any damages resulting from such improper use or sale.

Customers are responsible for their products and applications using Skyworks products, which may deviate from published specifications as a result of design defects, errors, or operation of products outside of published parameters or design specifications. Customers should include design and operating safeguards to minimize these and other risks. Skyworks assumes no liability for applications assistance, customer product design, or damage to any equipment resulting from the use of Skyworks products outside of stated published specifications or parameters.

Skyworks, the Skyworks symbol, and "Breakthrough Simplicity" are trademarks or registered trademarks of Skyworks Solutions, Inc., in the United States and other countries. Third-party brands and names are for identification purposes only, and are the property of their respective owners. Additional information, including relevant terms and conditions, posted at www.skyworksinc.com, are incorporated by reference.